



BONTEMPI[®]
Chirurgische Instrumente

Gynecology
Gynäkologie
Ginecologia
Ginecologia
Gynécologie



Pinze per
calcoli renali

Kidney stone
forceps

Nierensteinzangen

Pinces pour
les calculs renaux

Pinzas para
cálculos renales

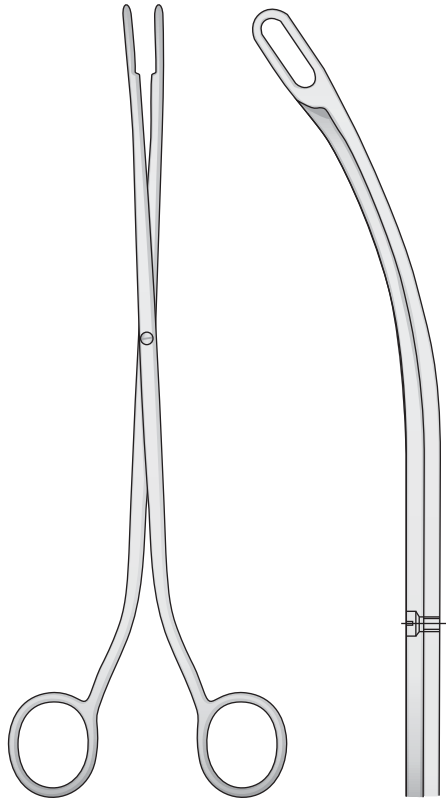

DESJARDINS
EB-11/EB-14
225 mm

Fig. 1



EB-11

Fig. 2



EB-12

Fig. 3



EB-13

Fig. 4



EB-14

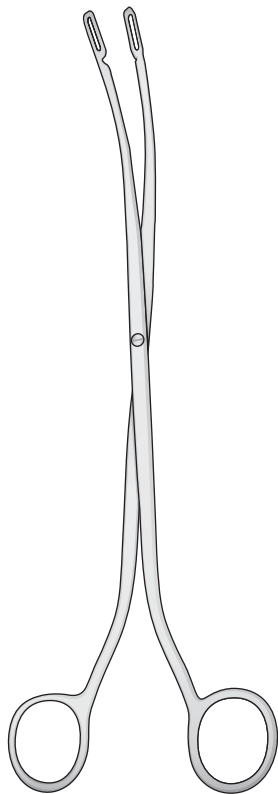

RANDALL
EB-36/EB-39
225 mm

Fig. 1

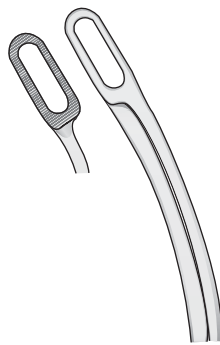

EB-36

Fig. 2



EB-37

Fig. 3



EB-38

Fig. 4

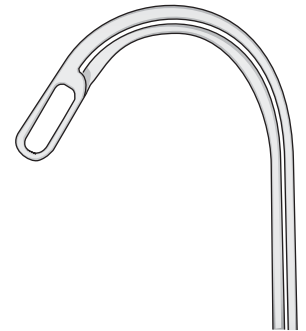

EB-39



Cateteri
Sonde metalliche

Catheters metal

Katheterspanner
Metallkatheter

Sondes métalliques

Catéteres
Sondas metálicas

Strumenti per tendere ed introdurre i cateteri
Catheter introducing instruments
Katheter-Einführungsinstrumente
Mandrin pour introduire les sondes
Instrumentos para introducir catéteres

Ø 1,2 mm

Ø 3 mm

Per uomini
For men
Für Männer
Pour hommes
Para hombres

Charr.

EA-60	8
EA-62	10
EA-63	12
EA-64	14
EA-65	16
EA-66	18
EA-67	20

Ø 2,7 mm

Per donne
For woman
Für Frauen
Pour femmes
Para mujeres

Charr.

EA-70	6
EA-72	8
EA-74	10
EA-76	12
EA-77	14
EA-78	16
EA-79	18

Ø 3 mm

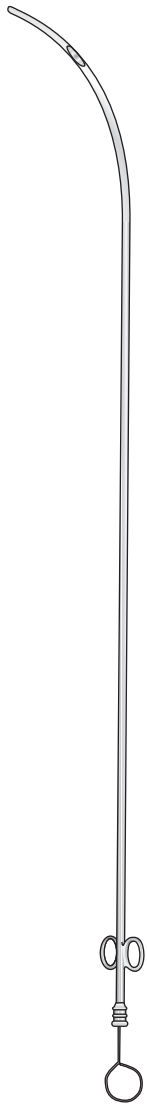

EA-60/EA-67
290 mm



EA-70/EA-79
160 mm

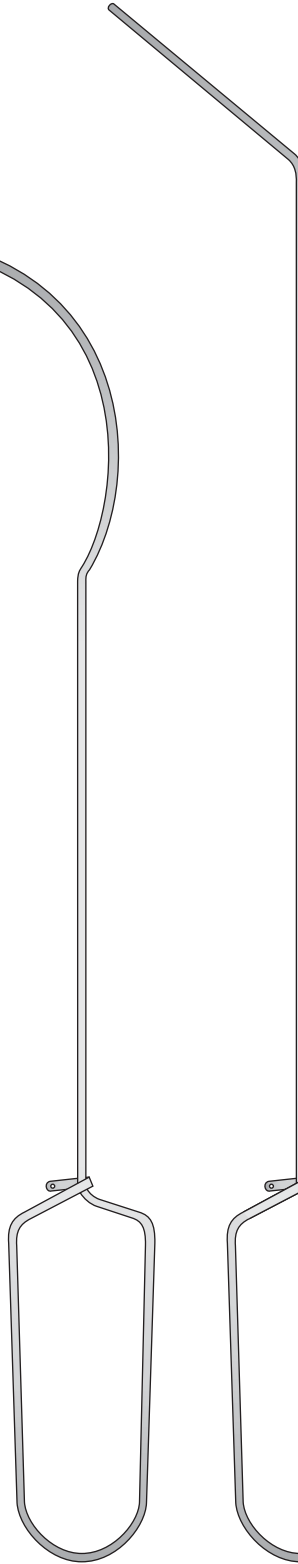

GUYON
EA-90
365 mm

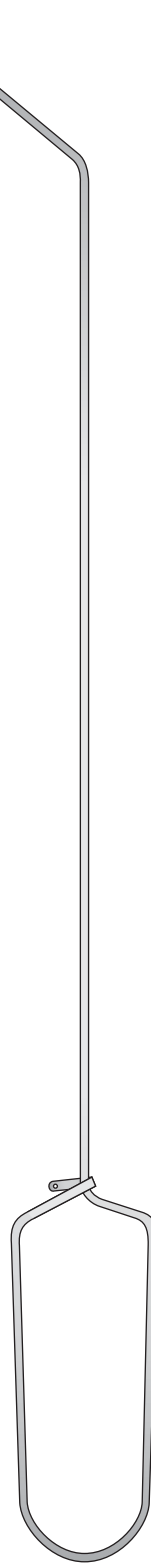

BENIQUE
EA-91
410 mm

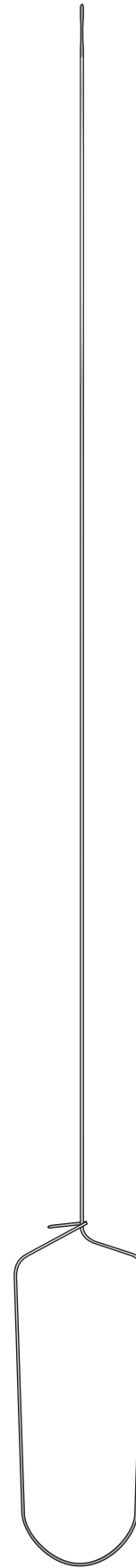

EA-93
460 mm

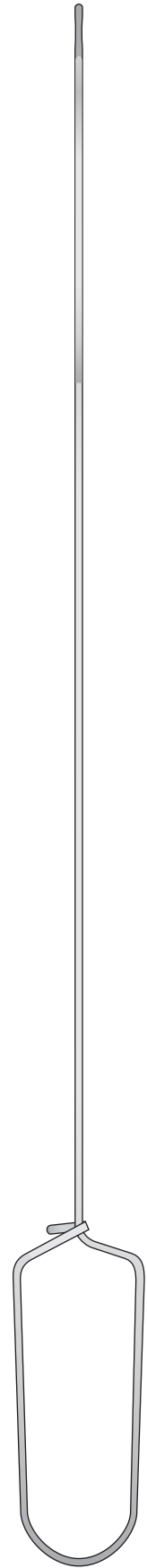

EA-92
460 mm



Dilatatori per
vie biliari

Gall duct
dilators

Gallengang-
Dilatatoren

Dilatateurs pour
les voies biliaires

Dilatadores para
conductos biliares

FB-321 - 190 mm - Ø 3 mm
FB-322 - 190 mm - Ø 4 mm
FB-323 - 190 mm - Ø 5 mm
FB-324 - 190 mm - Ø 6 mm
FB-325 - 190 mm - Ø 7 mm
FB-326 - 190 mm - Ø 8 mm
FB-327 - 190 mm - Ø 9 mm
FB-328 - 190 mm - Ø 10 mm
FB-329 - 190 mm - Ø 11 mm

FB-331 - 300 mm - Ø 1 mm
FB-332 - 300 mm - Ø 2 mm
FB-333 - 300 mm - Ø 3 mm
FB-334 - 300 mm - Ø 4 mm
FB-335 - 300 mm - Ø 5 mm
FB-336 - 300 mm - Ø 6 mm
FB-337 - 300 mm - Ø 7 mm
FB-338 - 300 mm - Ø 8 mm
FB-339 - 300 mm - Ø 9 mm
FB-340 - 300 mm - Ø 10 mm
FB-341 - 300 mm - Ø 11 mm
FB-342 - 300 mm - Ø 12 mm
FB-343 - 300 mm - Ø 13 mm

FB-320
 Set di 9 pezzi con custodia
 Set of 9 pieces in canvas pocket
 Satz à 9 Stück in Leinentuchtasche
 Jeu de 9 pièces dans une poche en toile
 Juego de 9 unidades en bolsa de tela

FB-330
 Set di 13 pezzi
 Set of 13 pieces
 Satz à 13 Stück
 Jeu de 13 pièces
 Juego de 13 unidades

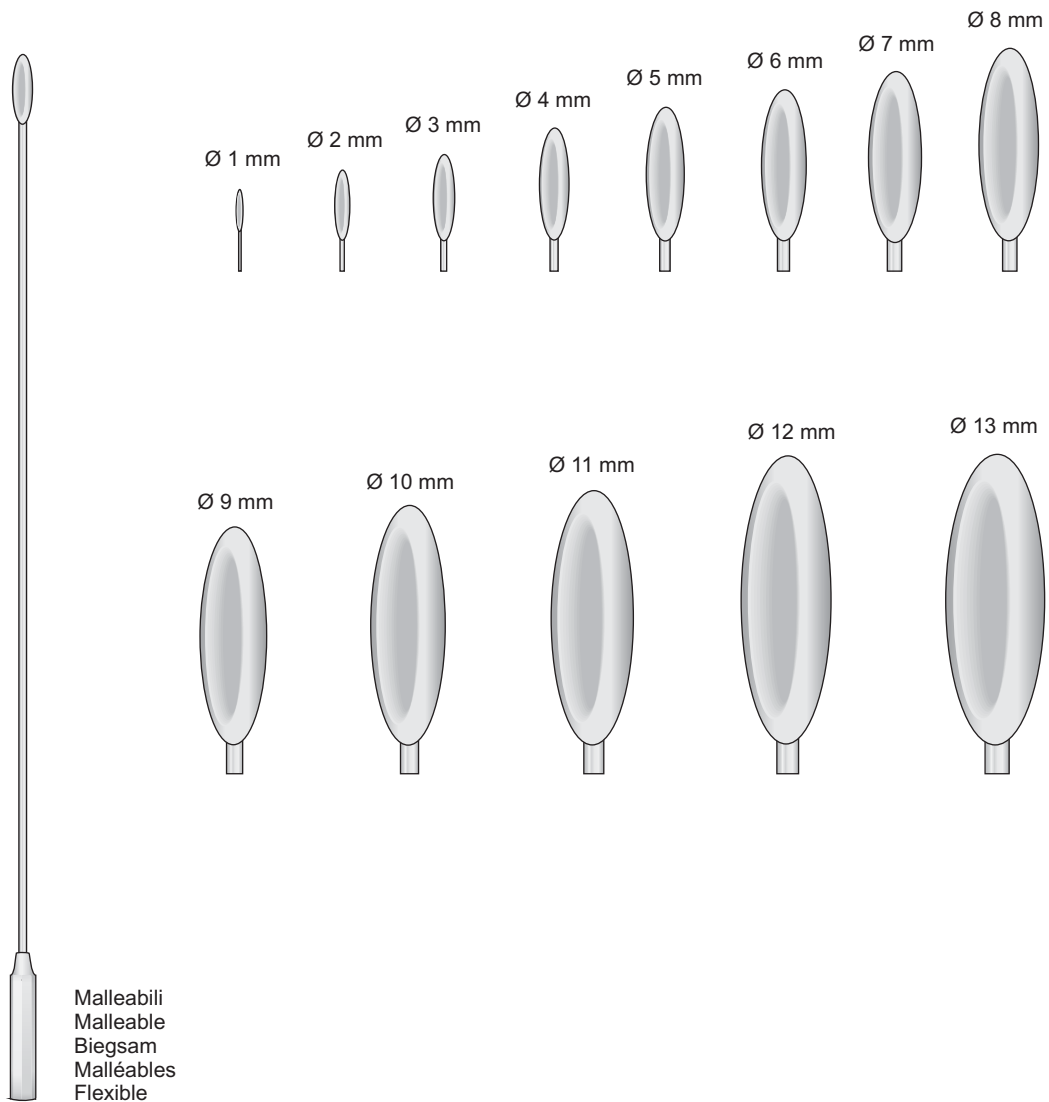

BAKES
FB-321/FB-343



Dilatatori per
vie biliari

Gall duct
dilators

Gallengang-
Dilatatoren

Dilatateurs pour
les voies biliaires

Dilatadores para
conductos biliares



DITTEL
EB-251/EB-267
220 mm

	Charr.
EB-251	8
EB-252	9
EB-253	10
EB-254	11
EB-255	12
EB-256	14
EB-257	16
EB-258	18
EB-259	20
EB-260	22
EB-261	24
EB-262	25
EB-263	26
EB-264	27
EB-265	28
EB-266	29
EB-267	30

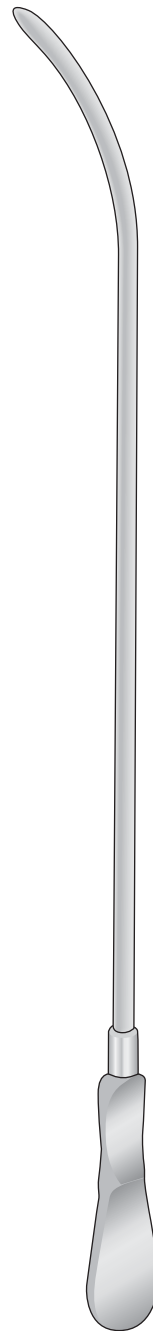

DITTEL
EB-201/EB-223
345 mm

	Charr.
EB-201	8
EB-202	9
EB-203	10
EB-204	11
EB-205	12
EB-206	13
EB-207	14
EB-208	15
EB-209	16
EB-210	17
EB-211	18
EB-212	19
EB-213	20
EB-214	21
EB-215	22
EB-216	23
EB-217	24
EB-218	25
EB-219	26
EB-220	27
EB-221	28
EB-222	29
EB-223	30



Dilatatori per
vie biliari

Gall duct
dilators

Gallengang-
Dilatatoren

Dilatateurs pour
les voies biliaires

Dilatadores para
conductos biliares

EB-49 - Ø 10 mm  1/1

EB-48 - Ø 9 mm  1/1

EB-47 - Ø 8 mm  1/1

EB-46 - Ø 7 mm  1/1

EB-45 - Ø 6 mm  1/1

EB-44 - Ø 5 mm  1/1

EB-43 - Ø 4 mm  1/1

EB-42 - Ø 3 mm  1/1

EB-42/EB-49
190 mm

**EB-250**

Set completo con 19 pezzi - Ch.12 / Ch.30
 Set complete with 19 pieces - Ch.12 / Ch.30
 Kompletset mit 19 Stück - Ch.12 / Ch.30
 Set complet avec 19 pièces - Ch.12 / Ch.30
 Set completo con 19 piezas - Ch.12 / Ch.30

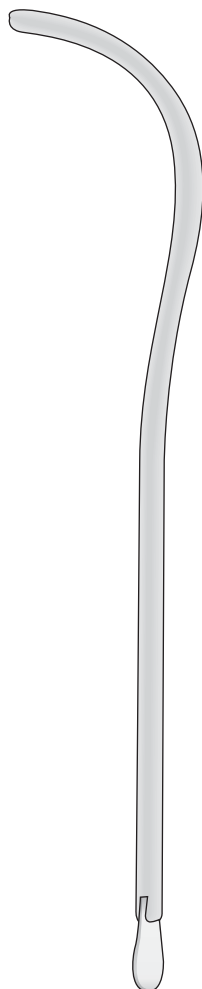

GUYON
EB-231/EB-249
 255 mm

Ben. Charr.

EB-231	24	12
EB-232	26	13
EB-233	28	14
EB-234	30	15
EB-235	32	16
EB-236	34	17
EB-237	36	18
EB-238	38	19
EB-239	40	20
EB-240	42	21
EB-241	44	22
EB-242	46	23
EB-243	48	24
EB-244	50	25
EB-245	52	26
EB-246	54	27
EB-247	56	28
EB-248	58	29
EB-249	60	30

Sonde per dotto biliare, Elastiche
 Gall Stone Probes, Elastic
 Gallensteinsonden, Federnd
 Explorateurs pour calculs biliaires, Élastiques
 Exploradores para cálculos biliares, Elásticos

Ø 4,3 mm

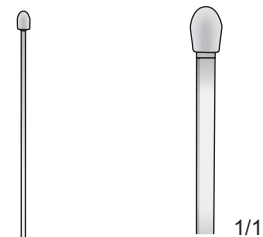

1/1

EB-18

Ø 6,0 mm

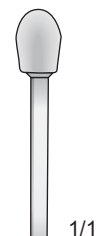

1/1

EB-19

Ø 7,0 mm

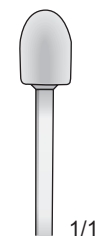

1/1

EB-20

DESJARDINS
EB-18/EB-20
 280 mm

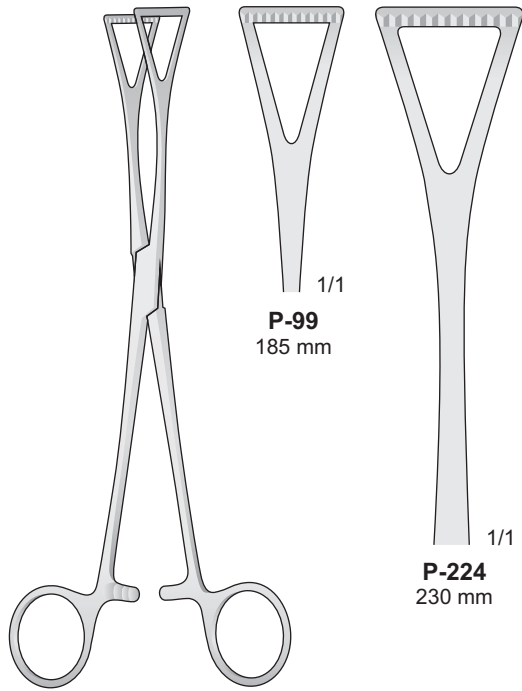

DUVAL
P-99/P-224

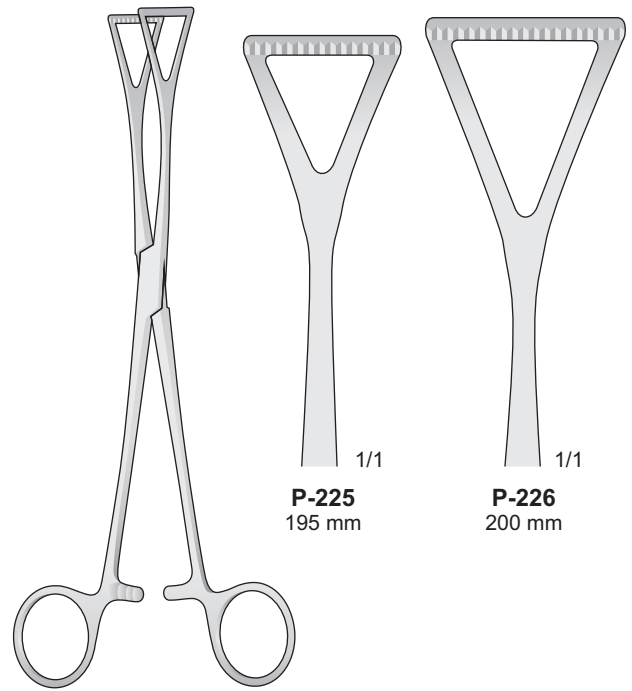

DUVAL-COLLIN
P-225/P-226

Pinze per peduncoli renali - Kidney pedicle clamp forceps - Nierenstielklemmen
Pincas-clamps pour pédicules rénaux - Pinzas-clamps para pedúnculos renales

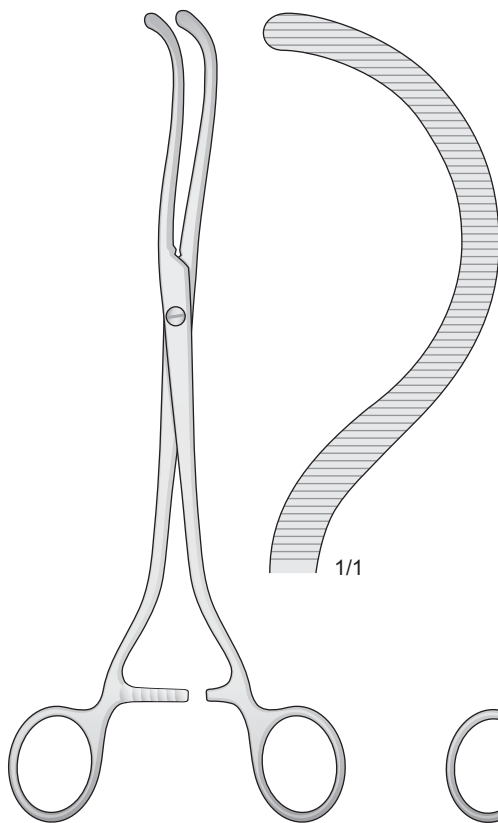

BRAUN
EB-30
245 mm

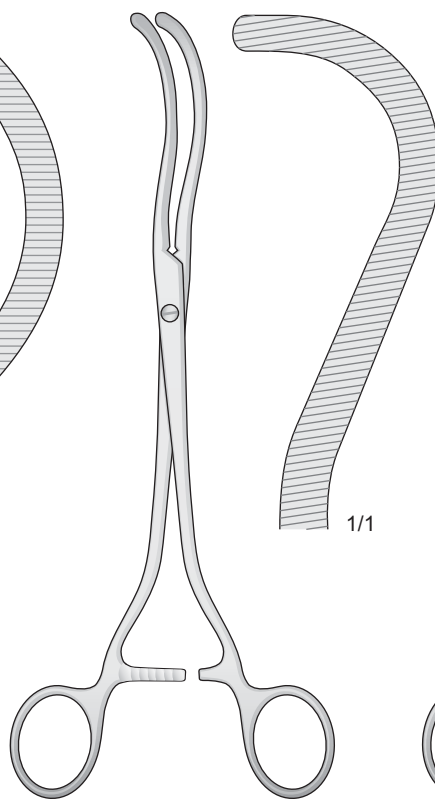

GUYON
EB-31
235 mm

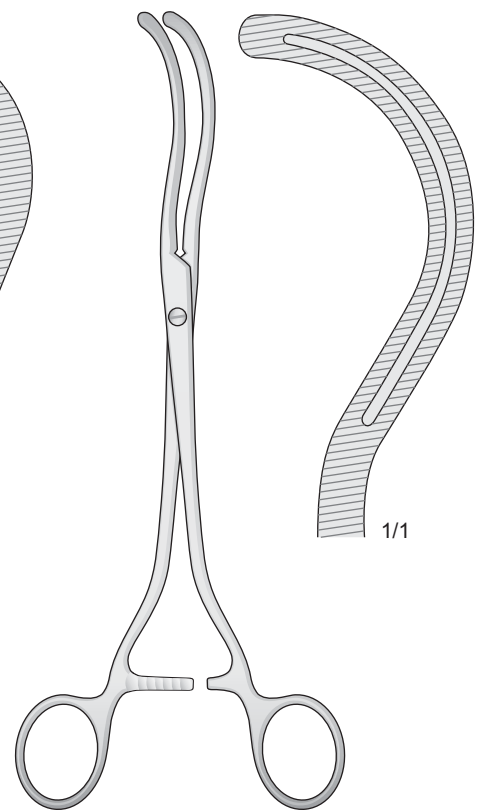

STILLE
EB-32
240 mm



Pinze per
peduncoli renali

Kidney pedicle
forceps

Nierenklemmen

Pinces-clamps pour
pédicules rénaux

Pinzas para
pedúnculos renales

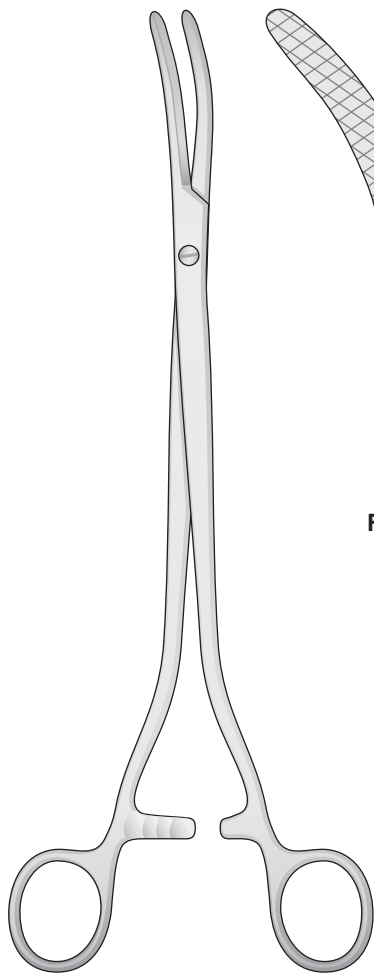

1/1
FB-41

WERTHEIM
FB-41
260 mm

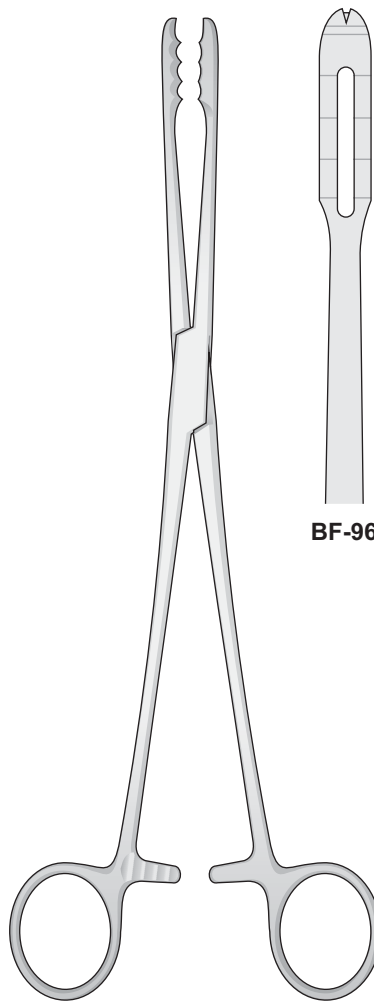

1/1
BF-96

1/1
BF-97

BF-96/BF-97
265 mm



Pinze per
peduncoli renali

Kidney pedicle
forceps

Nierenklemmen

Pinces-clamps pour
pédicules rénaux

Pinzas para
pedúnculos renales

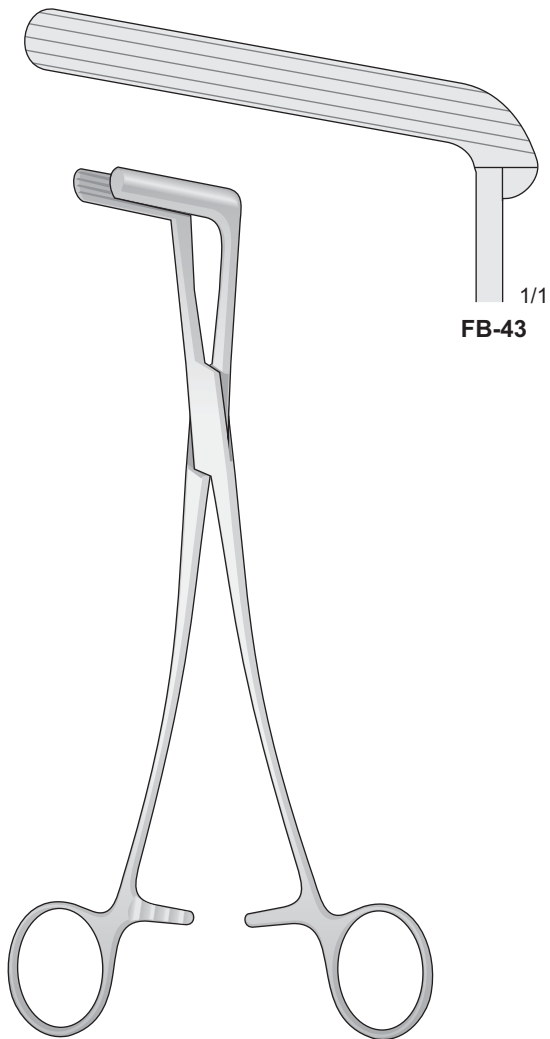

FB-43

WERTHEIM
FB-43
235 mm

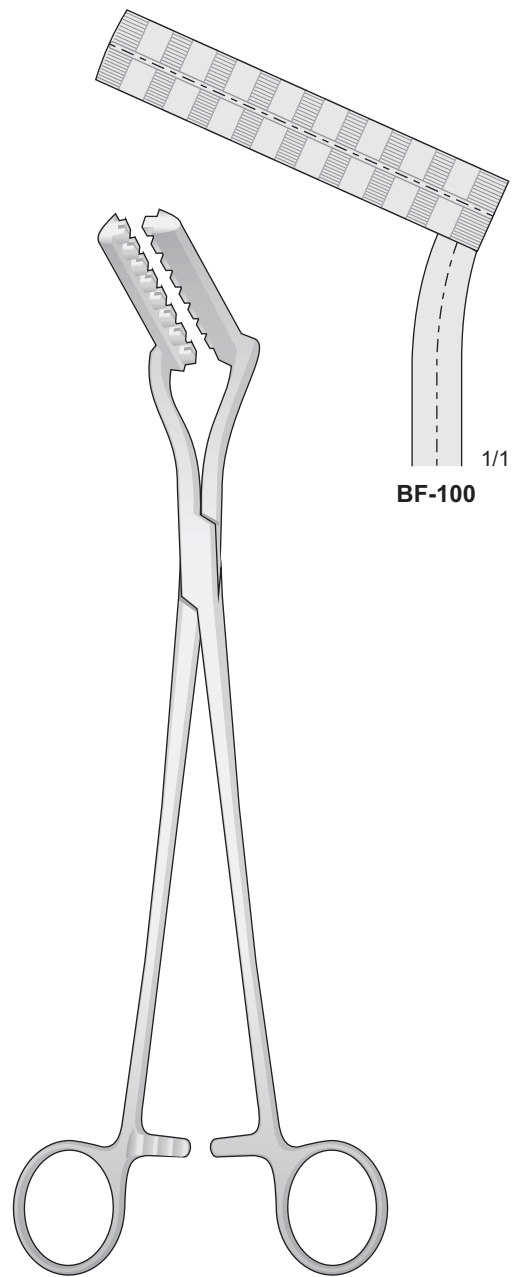

BF-100

BF-100
280 mm



Pinze da placenta
e aborto

Placenta
and ovum forceps

Placentar
und Abortuszangen

Pinces à faux
germes

Pinzas para
aborte

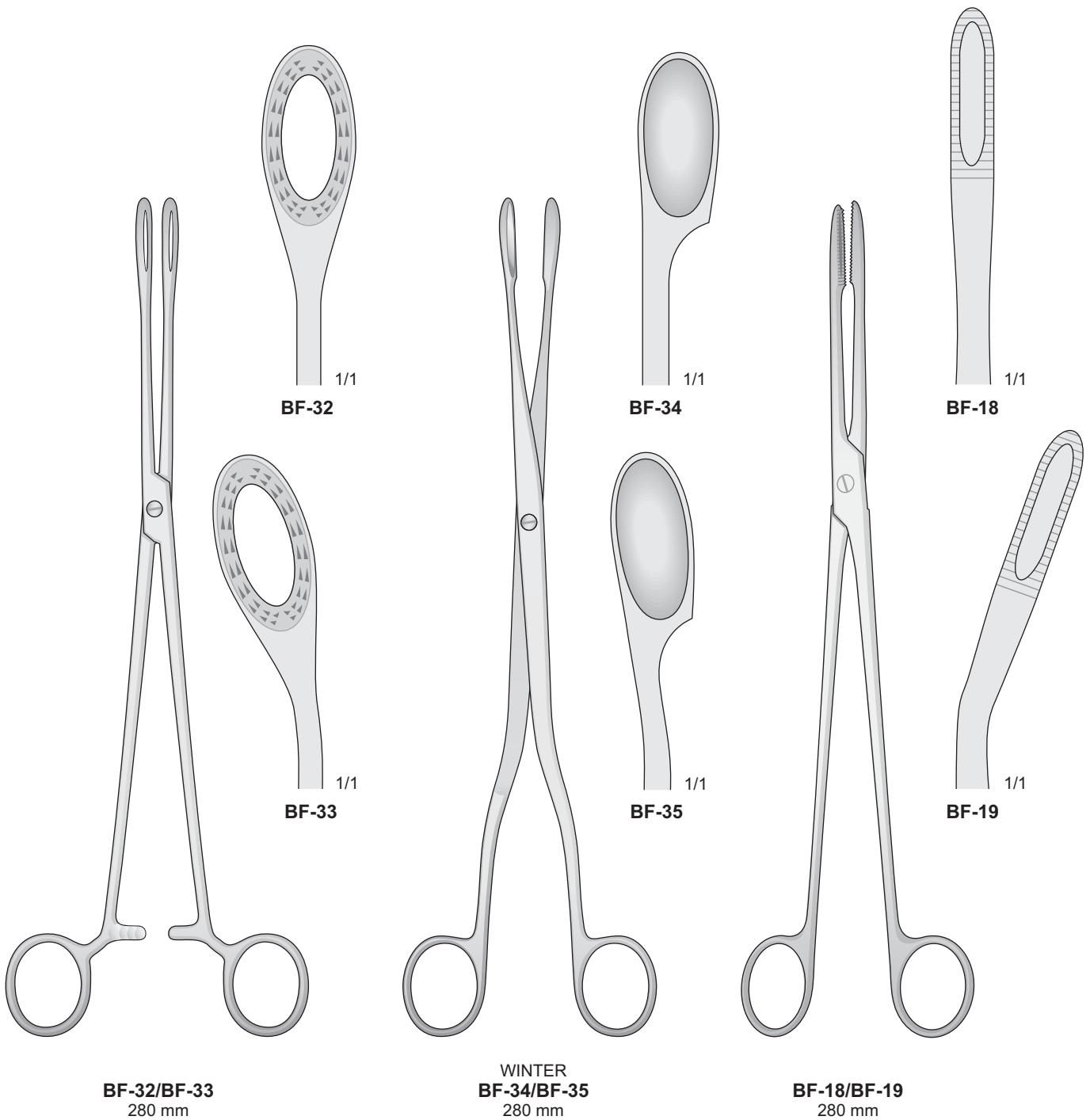



Pinze per tamponi
Pinze emostatiche

Cotton Swab forceps
Artery forceps

Tupferzangen
Arterienklemmen

Pinces à tampons
Pincés hemostáticas

Pinzas para tampones
Pinzas hemostáticas

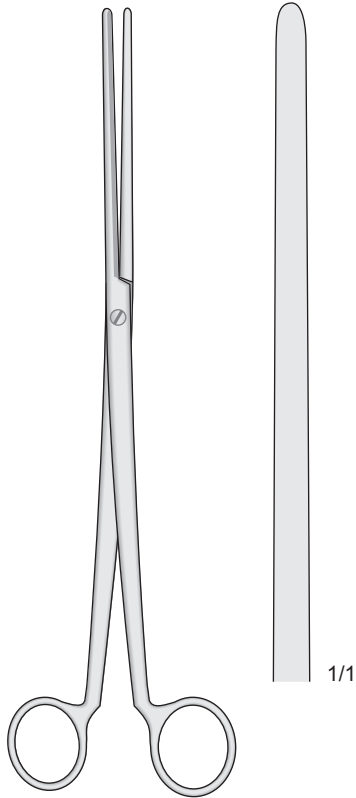

**COLLIN
BF-03**
260 mm

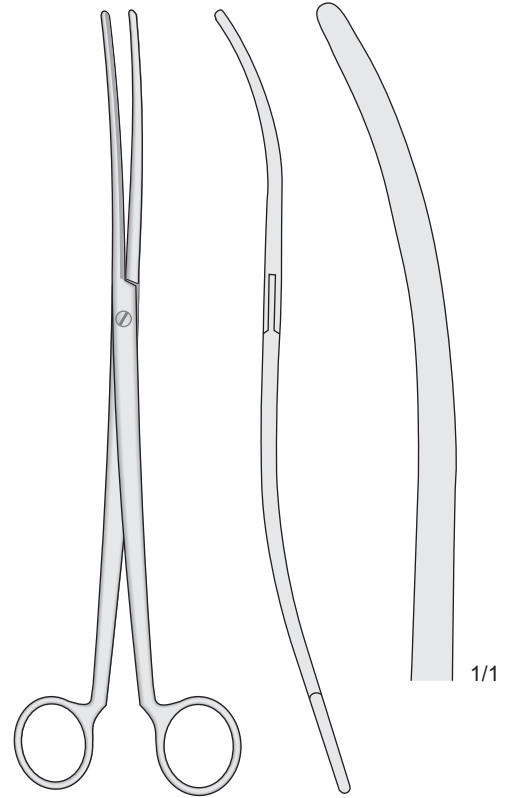

**COLLIN
BF-04**
260 mm

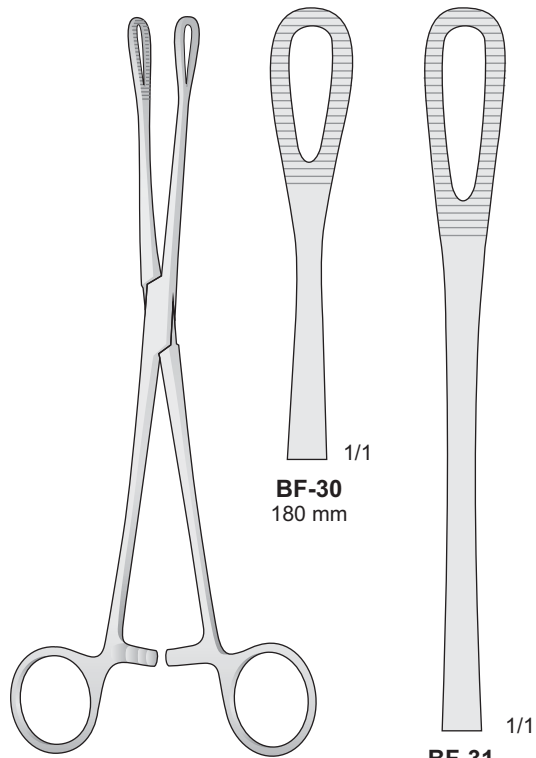

**RAMPLEY
BF-30/BF-31**

BF-31
245 mm

BF-30
180 mm

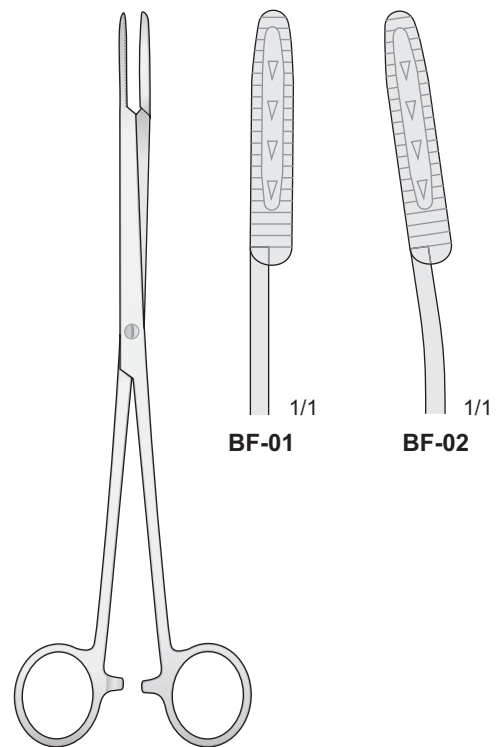

**MAIER
BF-01/BF-02**
245 mm

BF-01

BF-02

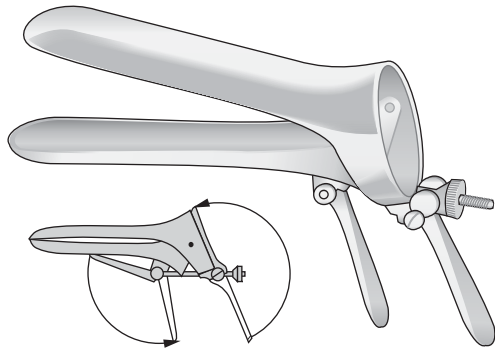

CUSCO
ER-49 Fig. 0 77x17 mm
ER-48 Fig. 1 75x33 mm
ER-47 Fig. 2 86x36 mm
ER-46 Fig. 3 97x36 mm

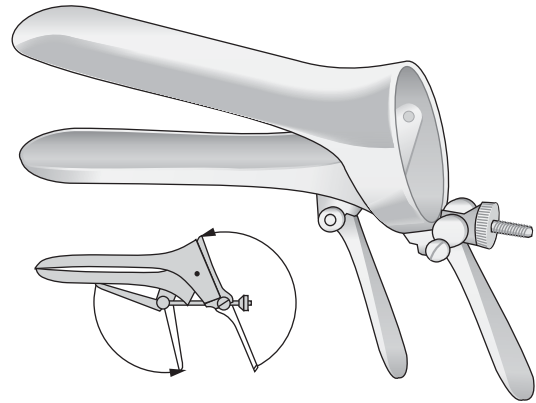

CUSCO
SCHWEIZER MODELL
ER-61 Fig.1 90x23 mm
ER-62 Fig.2 100x24 mm
ER-63 Fig.3 105x27 mm

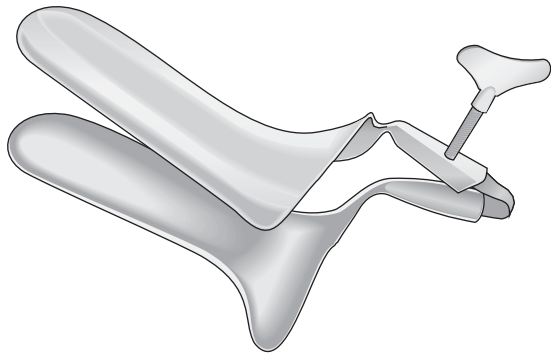

COLLIN-STANDARD
ER-72 Fig. 1 90x29 mm
ER-73 Fig. 2 95x35 mm
ER-74 Fig. 3 110x40 mm

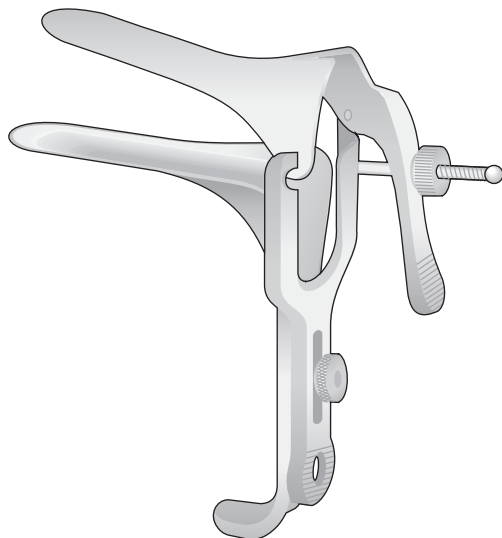

GRAVE
ER-91 75x20 mm
ER-92 95x30 mm
ER-93 105x33 mm

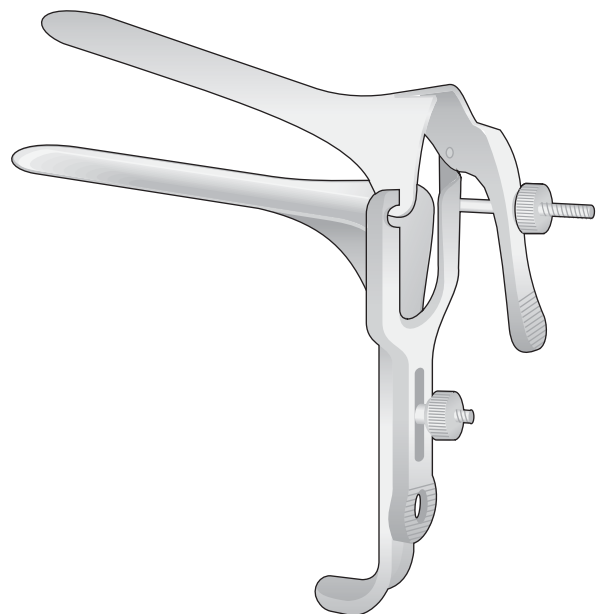

PEDERSON
ER-96 100x22 mm
ER-97 120x25 mm



Speculum e valve vaginali

Vaginal specula

Scheidenspekula und halter

Spéculums et valves vaginaux

Espéculos vaginales



KALLMORGEN
EB-101 - 70 x 40 mm
170 mm

EB-102 - 70 x 33 mm
170 mm

EB-100
Set 2 pezzi - Set 2 pieces
Set 2 stück - Set 2 pièces
Set 2 piezas
70 x 40 mm
70 x 33 mm

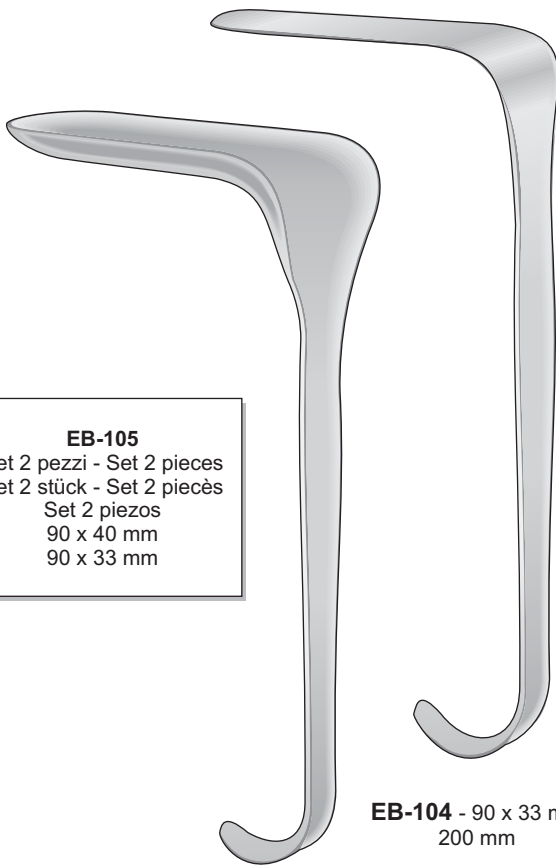

KALLMORGEN
EB-103 - 90 x 40 mm
200 mm

EB-104 - 90 x 33 mm
200 mm

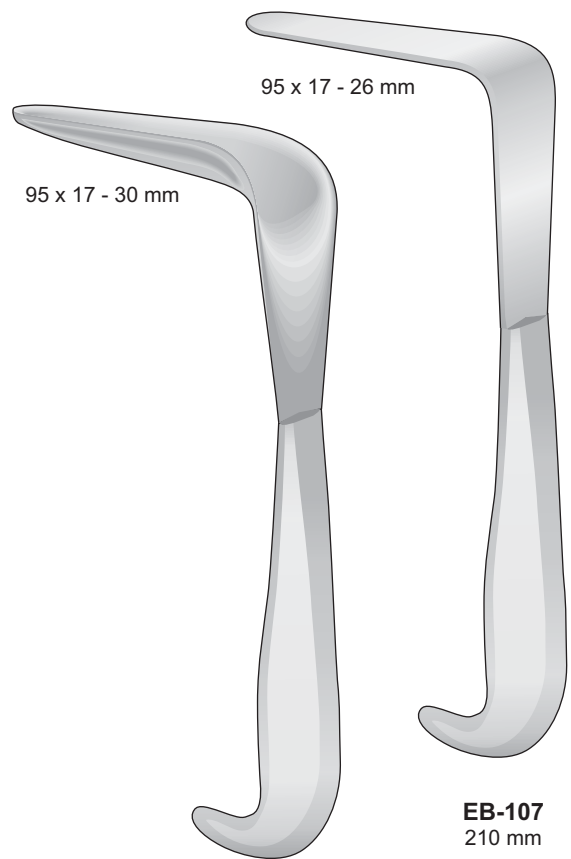

EB-105
Set 2 pezzi - Set 2 pieces
Set 2 stück - Set 2 pièces
Set 2 piezas
90 x 40 mm
90 x 33 mm

95 x 17 - 26 mm

95 x 17 - 30 mm

MATHIEU
EB-106
210 mm

EB-107
210 mm



Speculum e valve vaginali

Vaginal specula

Scheidenspekula und halter

Spéculums et valves vaginaux

Espéculos vaginales

Speculum
Spekula
Specula
Spéculums
Espéculos



KRISTELLER

- Fig. 1 **EB-120** - 70 x 27 mm
- Fig. 2 **EB-121** - 75 x 30 mm
- Fig. 3 **EB-122** - 90 x 36 mm

Valva
Halter
Retractors
Valves
Valvas



KRISTELLER

- Fig. 1 **EB-123** - 75 x 23 mm
- Fig. 2 **EB-124** - 80 x 26 mm
- Fig. 3 **EB-125** - 95 x 32 mm

Speculum + Valva
Specula + Retractor
Spekula + Halter
Spéculum + Valve
Espéculo + Valva



- Fig. 1 **EB-126**
- Fig. 2 **EB-127**
- Fig. 3 **EB-128**

Speculum
Spekula
Specula
Spéculums
Espéculos



KRISTELLER

- Fig. 00 **EB-130** - 110 x 18 mm
- Fig. 0 **EB-131** - 110 x 21 mm
- Fig. 1 **EB-132** - 110 x 27 mm
- Fig. 2 **EB-133** - 110 x 30 mm
- Fig. 3 **EB-134** - 110 x 36 mm

Valva
Halter
Retractors
Valves
Valvas



KRISTELLER

- Fig. 00 **EB-135** - 115 x 14 mm
- Fig. 0 **EB-136** - 115 x 17 mm
- Fig. 1 **EB-137** - 115 x 23 mm
- Fig. 2 **EB-138** - 115 x 26 mm
- Fig. 3 **EB-139** - 115 x 32 mm

Speculum + Valva
Specula + Retractor
Spekula + Halter
Spéculum + Valve
Espéculo + Valva



- Fig. 00 **EB-140**
- Fig. 0 **EB-141**
- Fig. 1 **EB-142**
- Fig. 2 **EB-143**
- Fig. 3 **EB-144**



DOYEN
EB-150/EB-166
240 mm

Fig. 1 **EB-150** - 60 x 35 mm
Fig. 2 **EB-151** - 90 x 35 mm
Fig. 3 **EB-152** - 120 x 35 mm

Fig. 1 **EB-156** - 60 x 45 mm
Fig. 2 **EB-157** - 90 x 45 mm
Fig. 3 **EB-158** - 120 x 45 mm
Fig. 4 **EB-160** - 160 x 45 mm

Fig. 1 **EB-162** - 60 x 60 mm
Fig. 2 **EB-163** - 90 x 60 mm
Fig. 3 **EB-164** - 120 x 60 mm
Fig. 4 **EB-166** - 160 x 60 mm

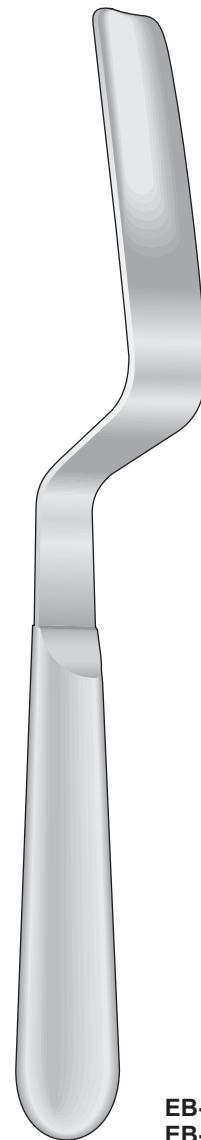

LANDAU
EB-190/EB-191
290 mm

EB-190 - 100 x 28 mm
EB-191 - 100 x 38 mm



Speculum vaginali

Vaginal specula

Scheidenspekula

Spéculums vaginaux

Espéculos vaginales



BREISKY

EB-170 - 100 x 20 mm
EB-171 - 100 x 25 mm
EB-172 - 100 x 30 mm
EB-173 - 100 x 35 mm
EB-174 - 100 x 40 mm
290 mm

BREISKY

EB-175 - 130 x 20 mm
EB-176 - 130 x 25 mm
EB-177 - 130 x 30 mm
EB-178 - 130 x 35 mm
EB-179 - 130 x 40 mm
320 mm

BREISKY

EB-184 - 160 x 40 mm
350 mm

BREISKY

EB-189 - 180 x 40 mm
370 mm



Dilatatori uterini

Uterine dilators

Uterus-Dilatatoren

Dilateurs du col de l'utérus

Dilatadores uterinos

Hegar Dilatatori - Hegar Dilators - Hegar Dilatoren - Hegar Dilateur - Hegar Diladores

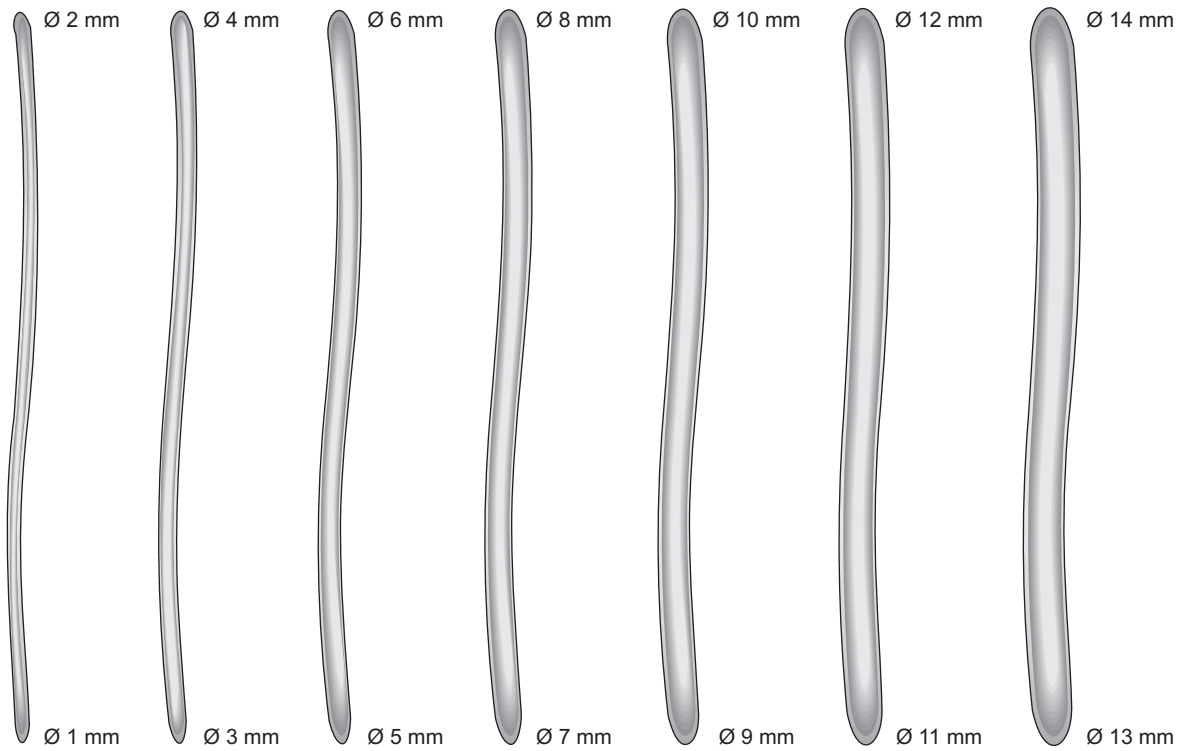

ER-120
200 mm

ER-121
200 mm

ER-122
200 mm

ER-123
200 mm

ER-124
200 mm

ER-125
200 mm

ER-126
200 mm

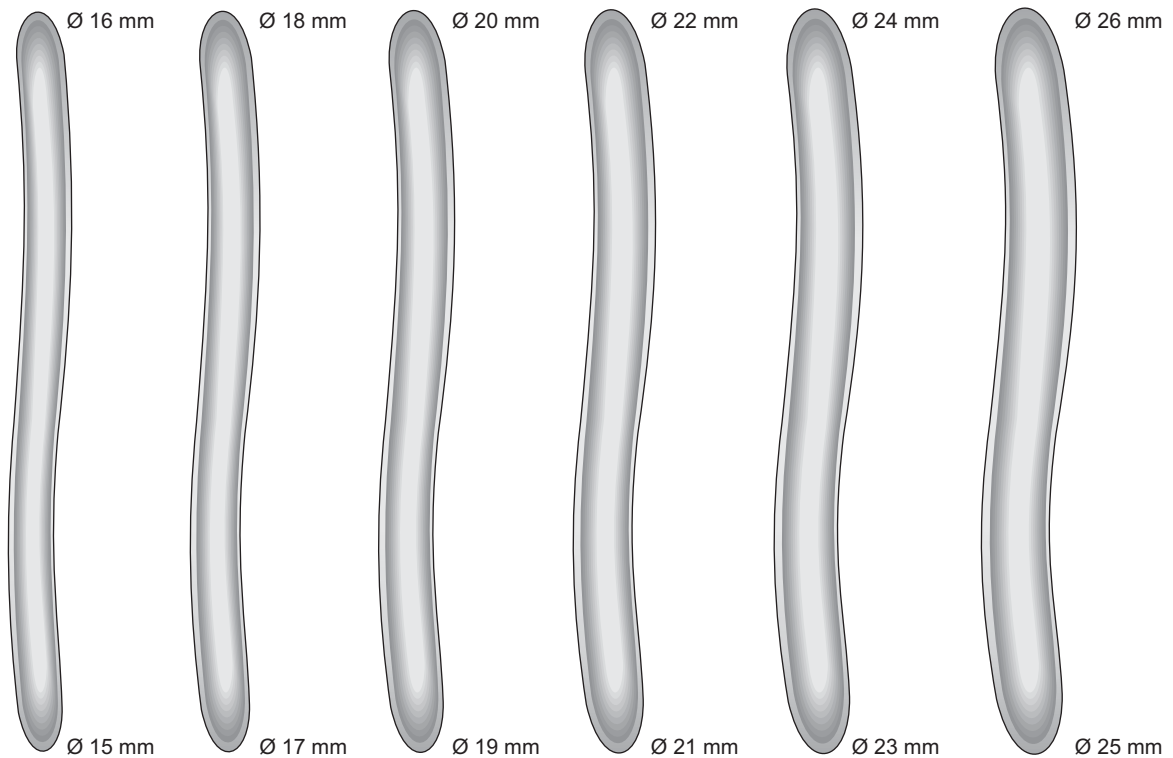

ER-127
200 mm

ER-128
200 mm

ER-129
200 mm

ER-130
200 mm

ER-131
200 mm

ER-132
200 mm

Pratt Dilatori - Pratt Dilators - Pratt Dilatoren
Pratt Dilateur - Pratt Diladores**ER-110**

Set completo dilatatori 8 pezzi
Set complete with 8 pieces
Satz-Dilatator, komplett, 8 Stück
Jeu complet avec 8 pieces
Juego completo con 8 piezas

Fig.	mm
13/15	4,5/5,0
17/19	5,6/6,3
21/23	7,0/7,6
25/27	8,3/9,0
29/31	9,6/10,3
33/35	11,0/11,6
37/39	12,3/13,0
41/43	13,6/14,3

La misura è in French
Breite in French

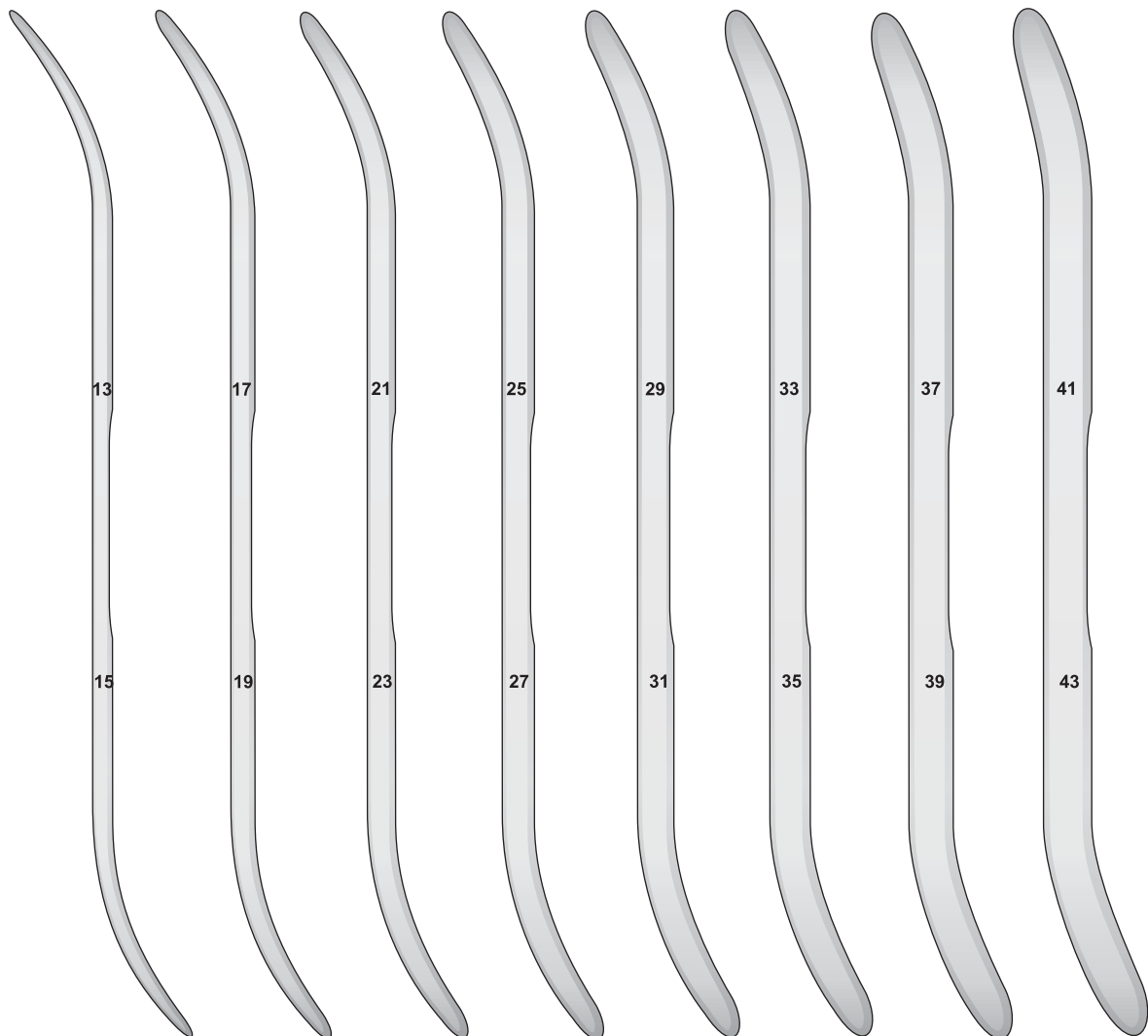

ER-111
260 mm

ER-112
260 mm

ER-113
260 mm

ER-114
260 mm

ER-115
260 mm

ER-116
260 mm

ER-117
260 mm

ER-118
260 mm



Dilatatori uterini

Uterine dilators

Uterus-Dilatatoren

Dilatateurs du col de l'utérus

Dilatadores uterinos



HEGAR
EB-51/EB-93
185 mm

EB-51 1 mm
 EB-52 2 mm
 EB-53 3 mm
 EB-54 4 mm
 EB-55 5 mm
 EB-56 6 mm
 EB-57 7 mm
 EB-58 8 mm
 EB-59 9 mm
 EB-60 10 mm
 EB-61 11 mm
 EB-62 12 mm
 EB-63 13 mm

EB-64 14 mm
 EB-65 15 mm
 EB-66 16 mm
 EB-67 17 mm
 EB-68 18 mm
 EB-69 19 mm
 EB-70 20 mm
 EB-71 21 mm
 EB-72 22 mm
 EB-73 23 mm
 EB-74 24 mm
 EB-75 25 mm
 EB-76 26 mm

EB-77 1½ mm
 EB-78 2½ mm
 EB-79 3½ mm
 EB-80 4½ mm
 EB-81 5½ mm
 EB-82 6½ mm
 EB-83 7½ mm
 EB-84 8½ mm
 EB-85 9½ mm
 EB-86 10½ mm
 EB-87 11½ mm
 EB-88 12½ mm
 EB-89 13½ mm

EB-90 14½ mm
 EB-91 15½ mm
 EB-92 16½ mm
 EB-93 17½ mm

Fig. 9/10
Ø 4,5/5,0 mm

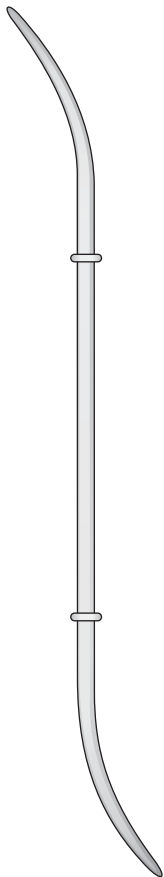

HANK
ER-161
260 mm

Fig. 11/12
Ø 5,5/6,0 mm

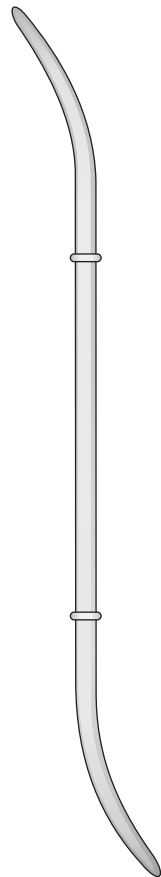

HANK
ER-162
260 mm

Fig. 13/14
Ø 6,5/7,0 mm

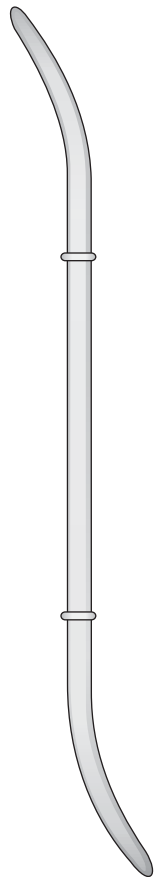

HANK
ER-163
260 mm

Fig. 15/16
Ø 7,5/8,0 mm

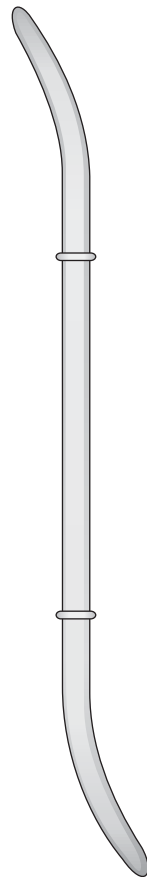

HANK
ER-164
260 mm

Fig. 17/18
Ø 8,5/9,0 mm

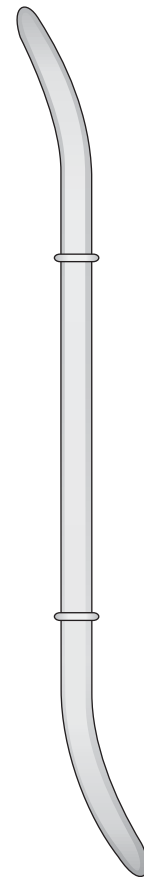

HANK
ER-165
260 mm

Fig. 19/20
Ø 9,5/10 mm

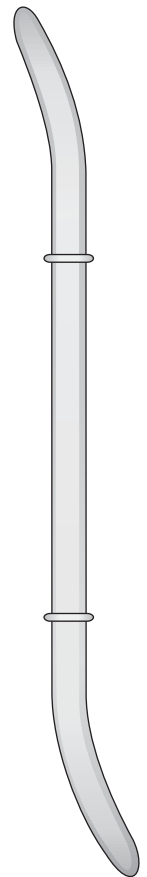

HANK
ER-166
260 mm



Isterometri

Uterine sounds

Uterussonden

Hystéromètres

Histeròmetros

Graduati in centimetri
Graduated in centimeters
Zentimetereinteilung
Gradué en centimètres
Graduado en centímetros

Malleabile
Malleable
Biigsam
Malléables
Maleables

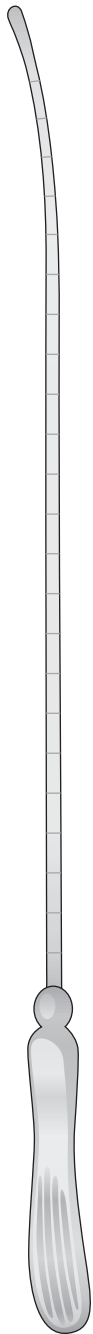

SIMS
ER-100/ER-102
320 mm

Malleabile
Malleable
Biigsam
Malléables
Maleables

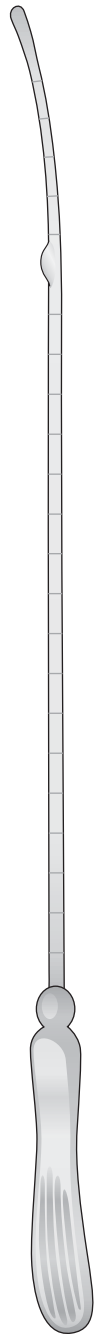

SIMPSON
ER-103 Ø 3 mm
320 mm

Rigido
Rigid
Fest
Rigides
Rigidos

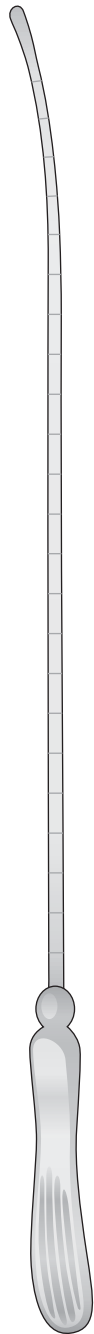

SIMS
ER-104/ER-105
320 mm

ER-104
Ø 3 mm
ER-105
Ø 4 mm



VALLEIX
ER-107 Ø 4 mm
265 mm

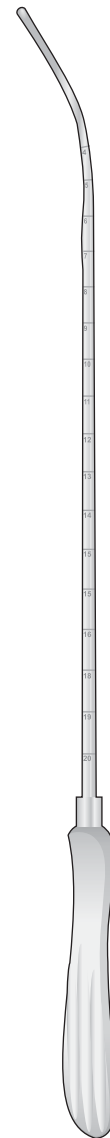

MARTIN
ER-106 Ø 3 mm
300 mm

Malleabile
Malleable
Biigsam
Malléables
Maleables



MAYO
ER-108 Ø 5 mm
330 mm



Pinze uterine

Uterine tenaculum forceps

Hakenzangen

Pinces pour l'utérus

Pinzas para coger el cuello del útero

Amniotomo per la
vescica amniotica
Amniotome for the
amnion bladder
Amniotom für die
Amnionblase
Amniotome pour la
vèsicule amniotique
Amniõtomo para la
vesicula amniõtica



BEACHAM
BF-55
260 mm

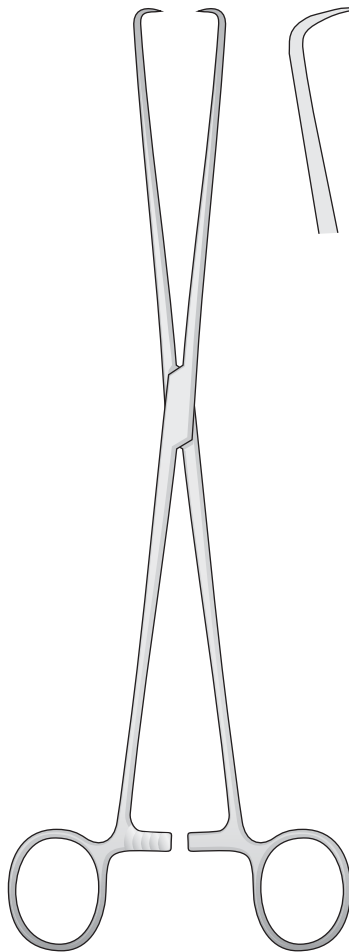

BRAUN
BF-49
250 mm

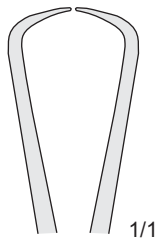

1/1

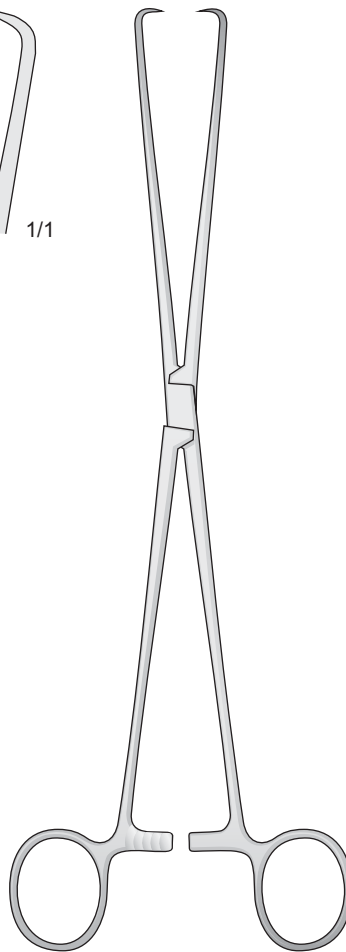

POZZI
BF-60
250 mm

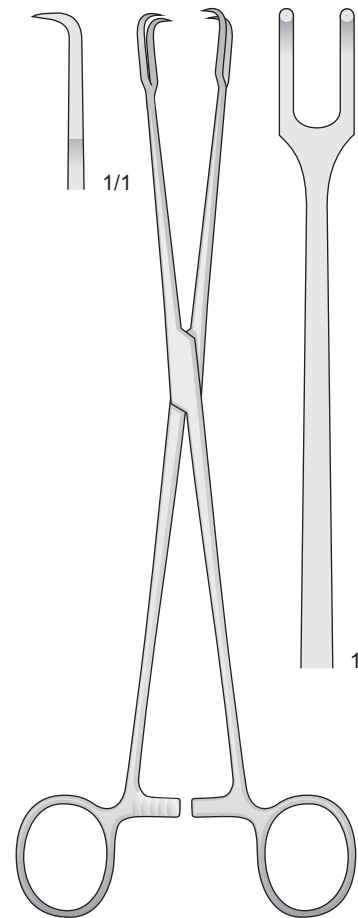

SCHROEDER
BF-59
240 mm

1/1

1/1



Pinze uterine

Uterine tenaculum forceps

Hakenzangen

Pinces pour l'utérus

Pinzas para coger el cuello del útero

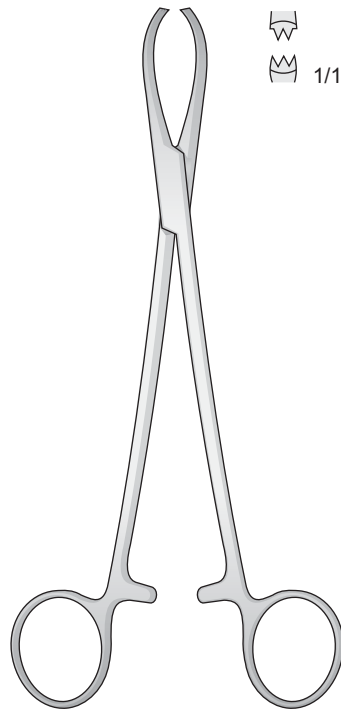

LITTLEWOOD
EB-25
185 mm

Con curvatura laterale
Curved Sideway
Seitwärts Gebogen
Courbes sur le côté
Curvas laterales

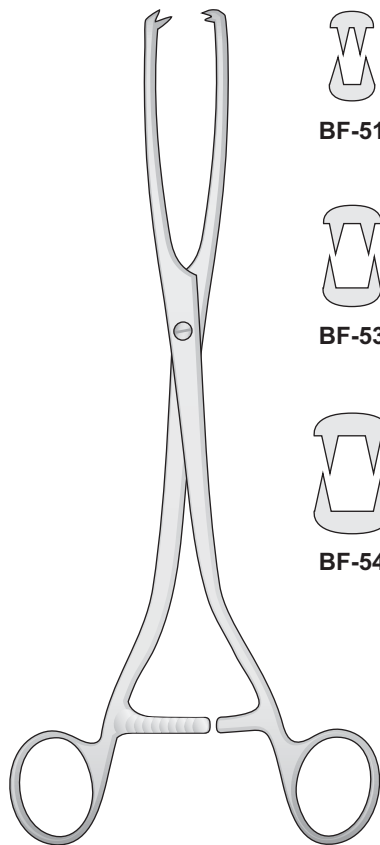

BF-51



BF-53

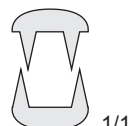

BF-54

MUSEUX
BF-51/BF-54
240 mm

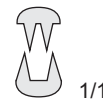
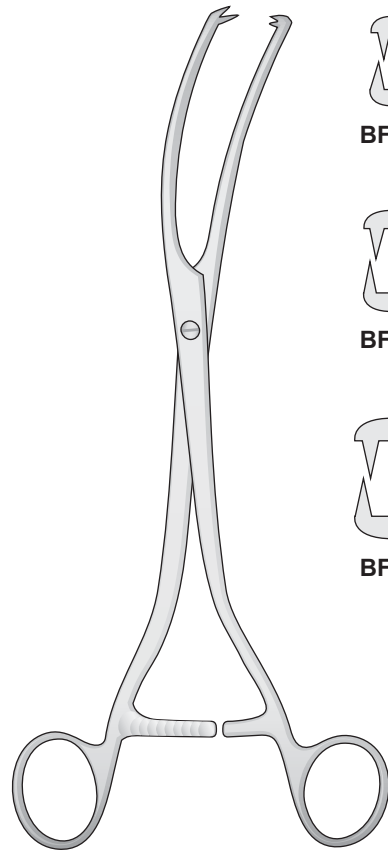

BF-61

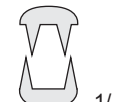

BF-62

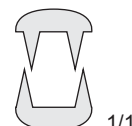

BF-63

MUSEUX
BF-61/BF-63
240 mm



Strumenti per fibromi
Strumenti per oper. Micro-tube

Myoma instruments
Instruments for
Micro tubal operation

Myom Instrumente
Instrumente für
Mikro-Tubenoperationen

Instruments
pour fibromes
Myomes

Instrumentos
para fibroma

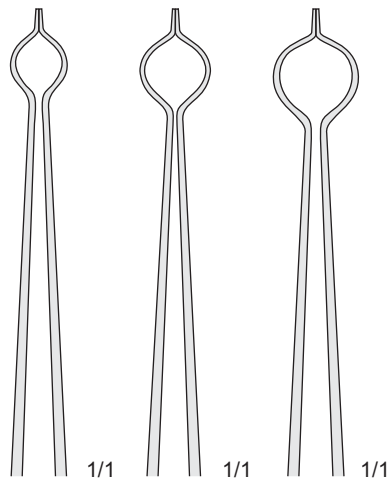
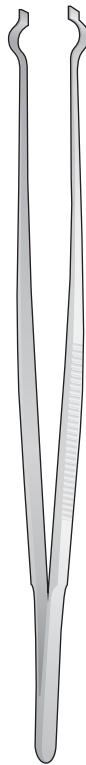

ER-150
Ø 6 mm

ER-151
Ø 8 mm

ER-152
Ø 10 mm

Pinzette per la presa delle tube
Tubal seizing forceps
Tubenfasspinzetten
Pinces pour saisir les tubes

NEUBÜSER
ER-150/ER-152
200 mm

Elevatori per miomi
Myoma screw
Myomheber
Tracteur pour fibromes
Tiramomas para fibromas



DOYEN
EB-15
150 mm

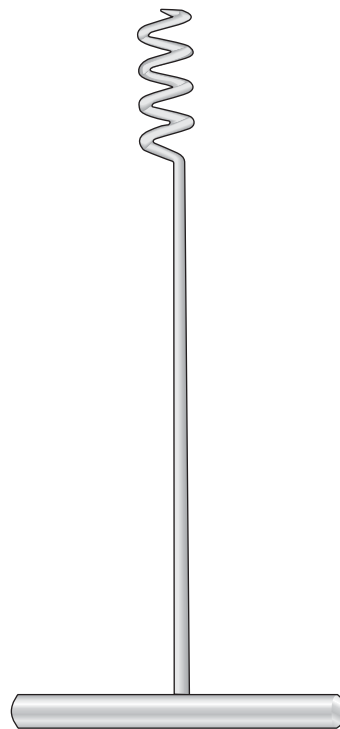

DOYEN
EB-16
170 mm



Curette di aspirazione
per biopsia

Uterine biopsy
aspirating curettes

Uterus Biopsie
Saugküretten

Curettes aspirantes
à biopsie de l'utérus

Curetas aspiradoras para
la biopsia uterina

Curette per biopsia endouterina
Endometrial Biopsy curette
Endometrium-Strickkürette
Curette pour biopsie intra-utérines
Cureta para biopsia endo-uterina

Curette per biopsia endocervicale
Endocervical Biopsy Curettes
Endocervix-Biopsieküretten
Curettes pour biopsies
endo-cervicales

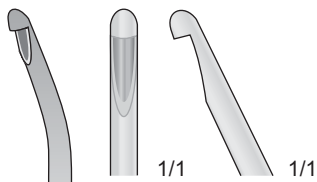

GF-108
3,5 mm

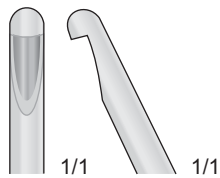

GF-109
5 mm

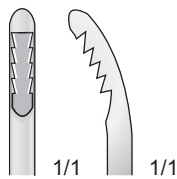

GF-135
Ø 1 mm
GF-136
Ø 2 mm
GF-137
Ø 3 mm
GF-138
Ø 4 mm

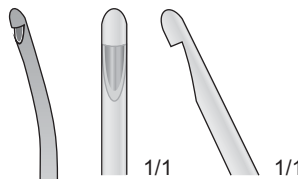

1/1 1/1

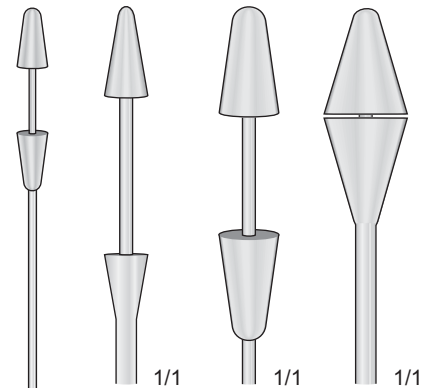

ER-77
Ø 5,7 mm

ER-78
Ø 8 mm

ER-79
Ø 11 mm

MÜNCHEN
GF-108/GF-109
270 mm

NOVAK
GF-135/GF-138
230 mm

RANDALL
GF-139
230 mm

GUSBERG
ER-77/ER-79
240 mm



Pinze per biopsie

Biopsy forceps

Biopsiezangen

Pinces à biopsies

Pinzas para biopsia

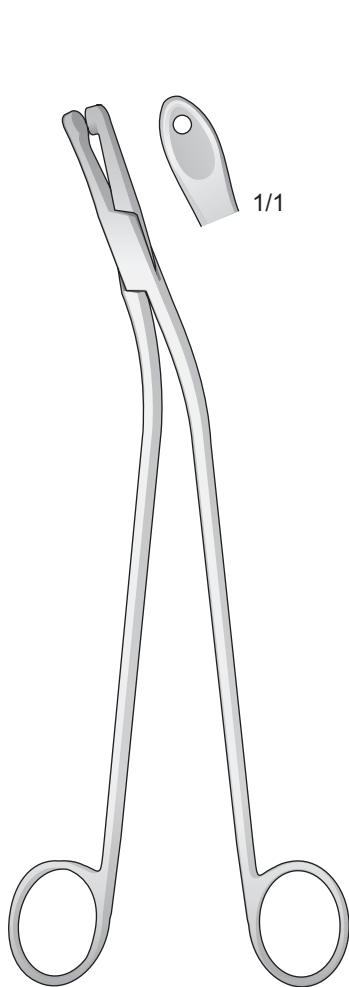

GELLHORN
FF-30
230 mm

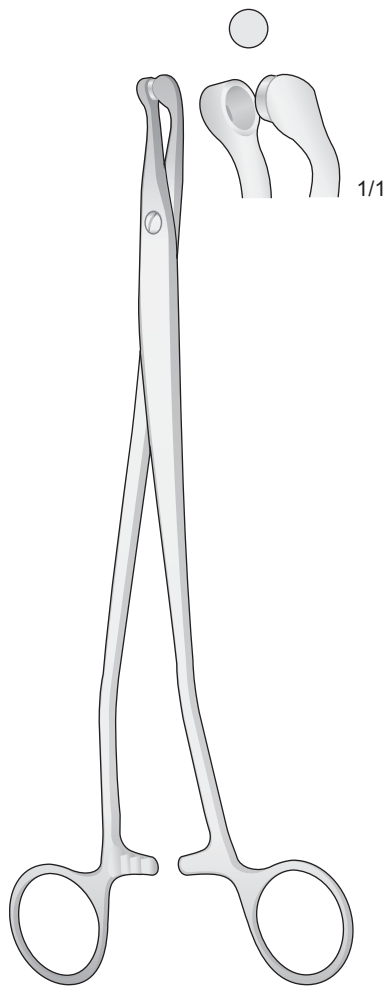

THOMS-GAYLOR
FF-32
240 mm

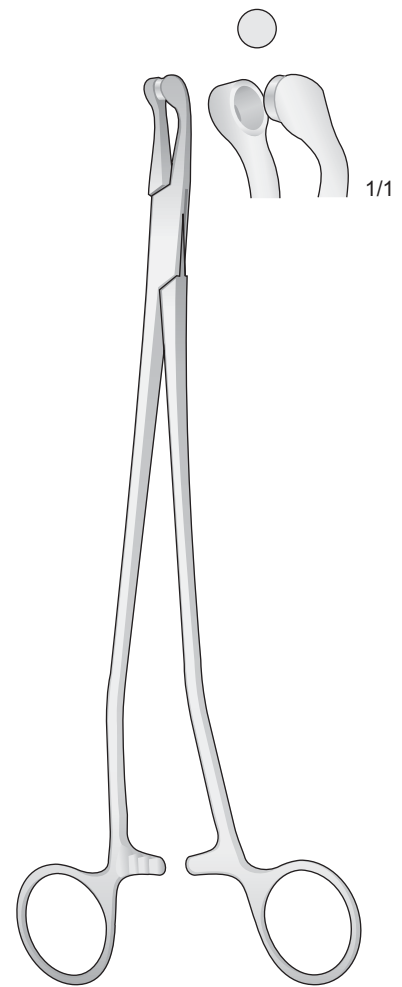

THOMS-GAYLOR
FF-33 220 mm
FF-34 240 mm



Pinze per biopsie

Biopsy forceps

Biopsiezangen

Pinces à biopsies

Pinzas para biopsia

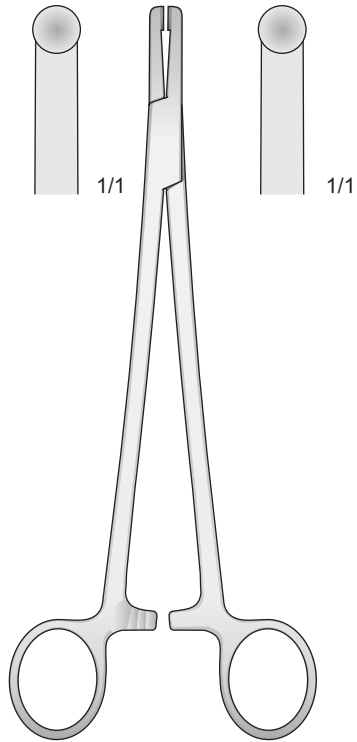

DB-150
205 mm

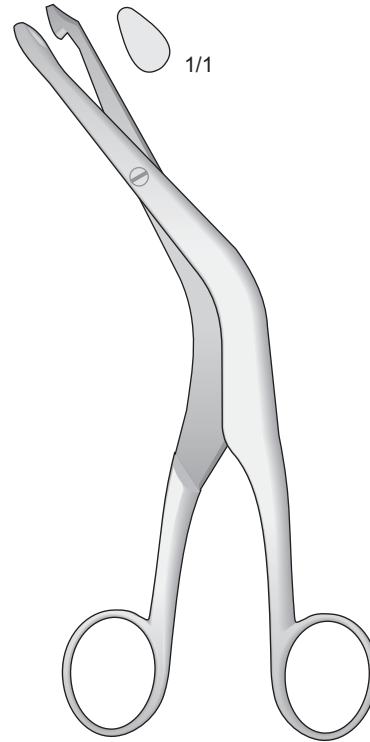

FAURE
FF-31
210 mm

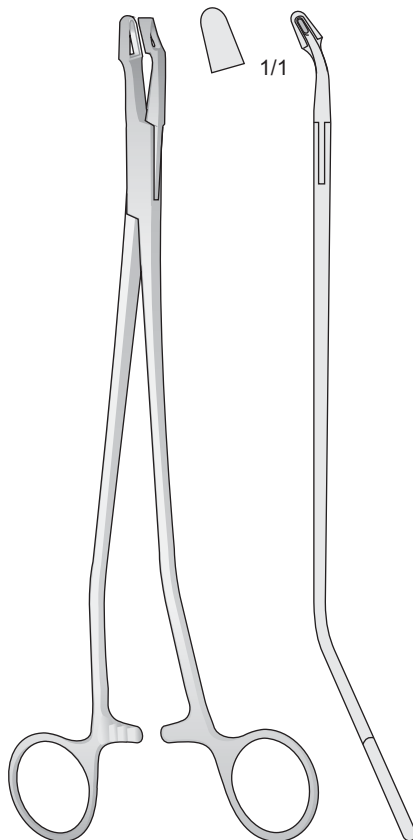

VAN DOREN
FF-39
250 mm

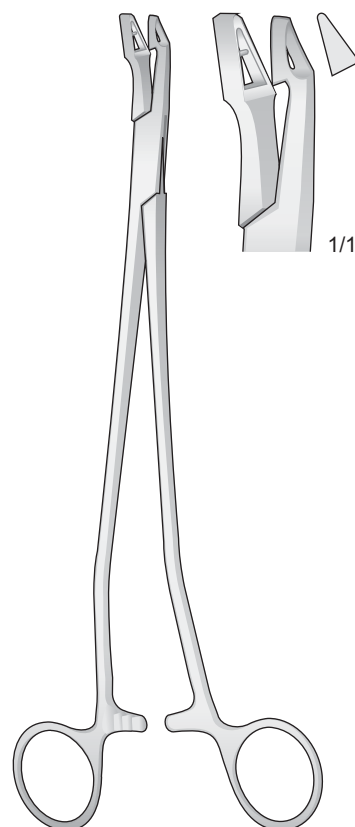

VAN DOREN
FF-38
240 mm



Pinze per biopsie

Biopsy forceps

Biopsiezangen

Pinces à biopsies

Pinzas para biopsia

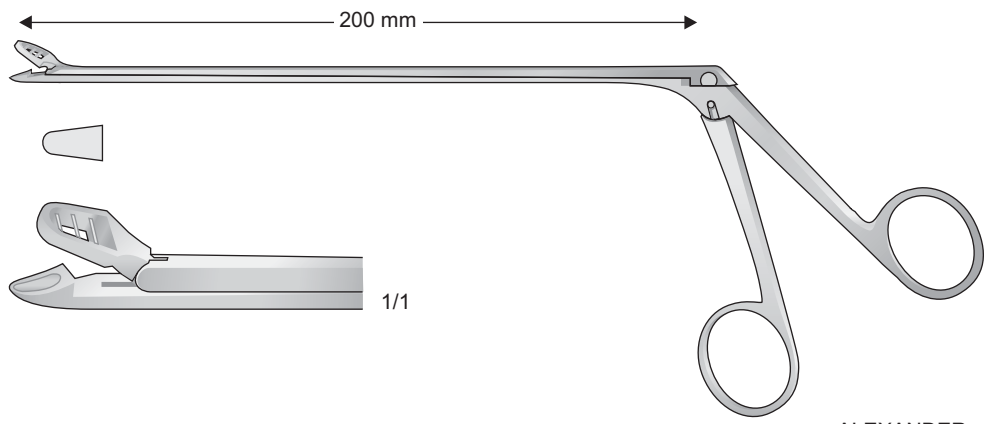

ALEXANDER
FF-64

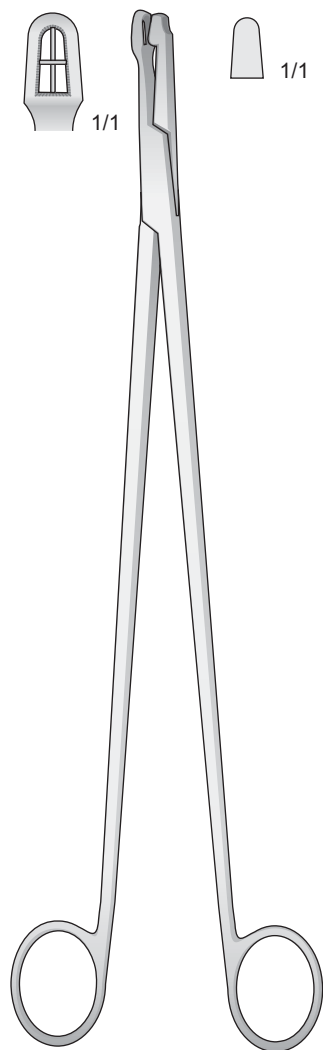

SCHUBERT
FF-35 210 mm
FF-36 290 mm

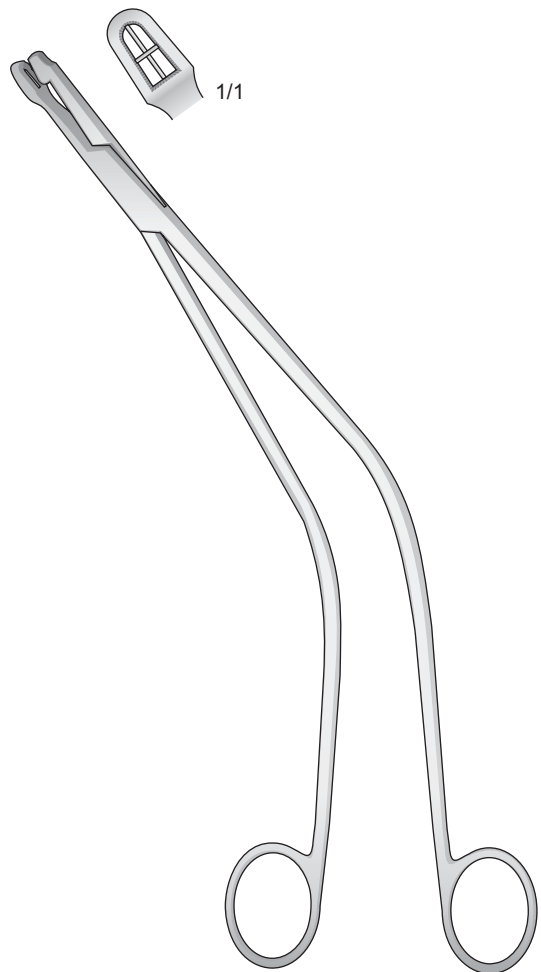

SCHUBERT
FF-37
260 mm



Pinze per biopsie

Biopsy forceps

Biopsiezangen

Pinces à biopsies

Pinzas para biopsia

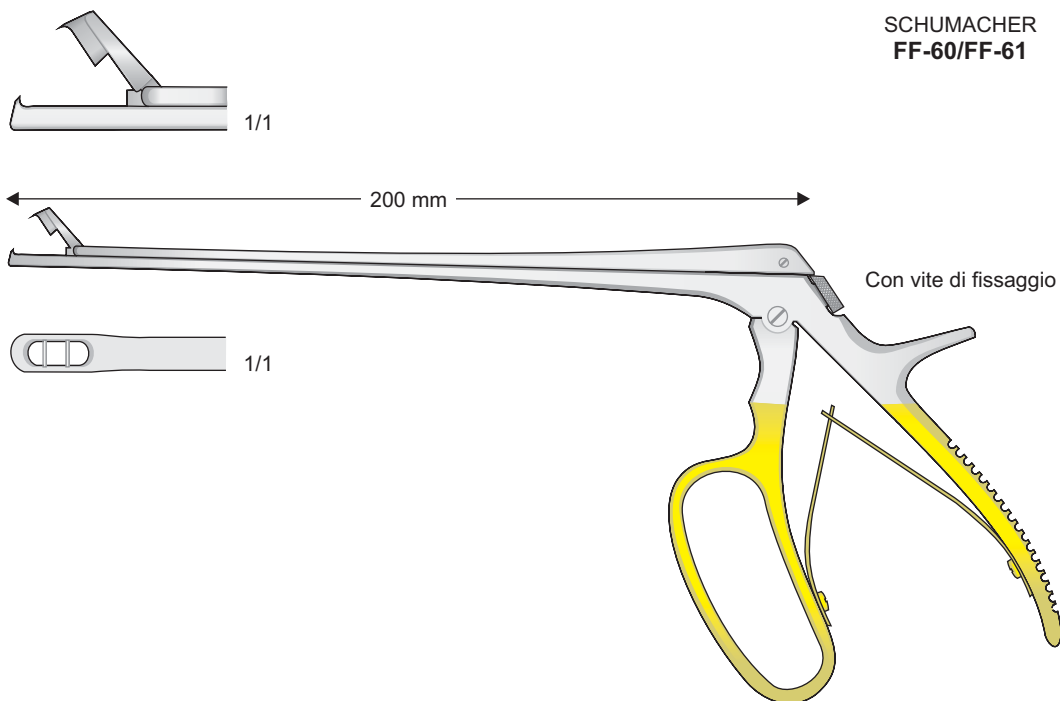
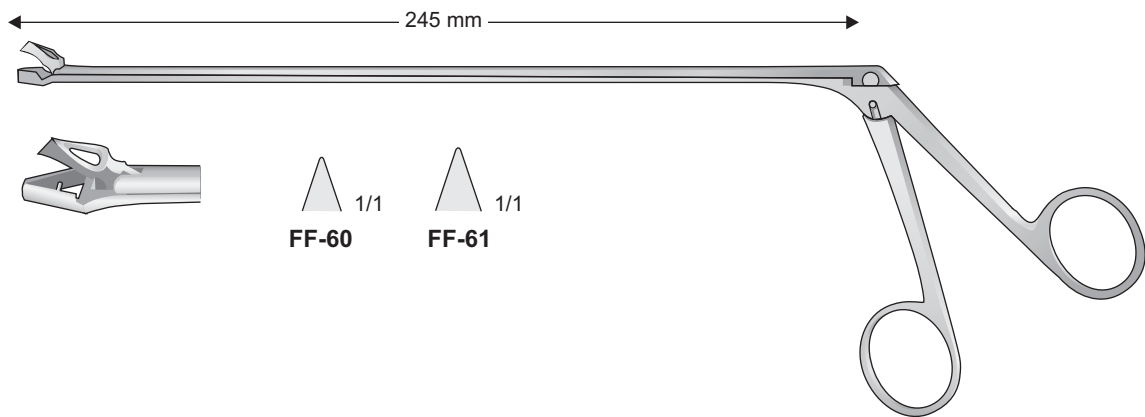
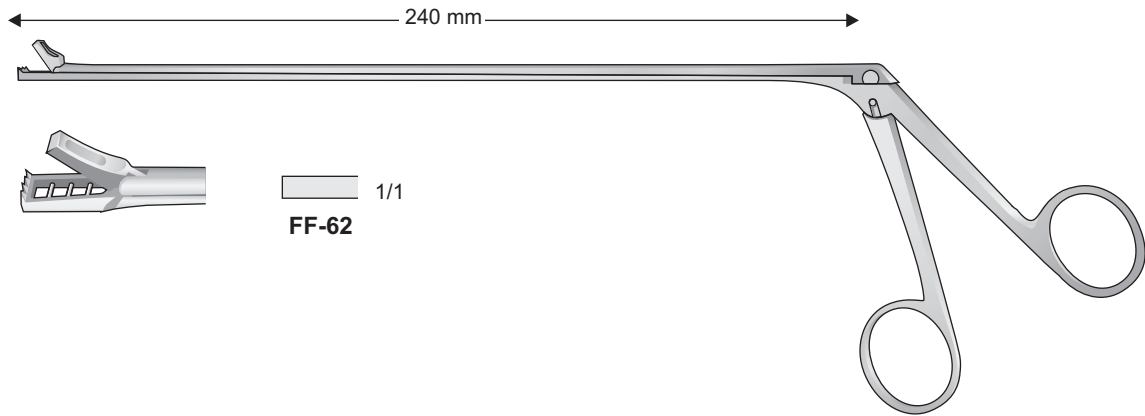



Curette uterine

Uterine curettes

Uterusküretten

Utérines cures

Curetas uterinas

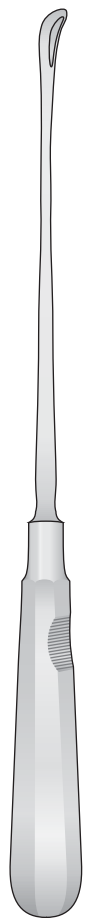

LUER-KÖRTE
EB-21/EB-23
260 mm

5,5 mm

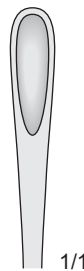

EB-21 1/1

7 mm

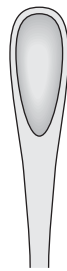

EB-22 1/1

11 mm



EB-23 1/1

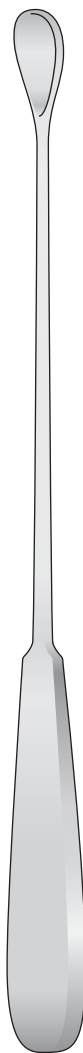

GOURDET
ER-80/ER-84
280 mm

Smusse - Blunt
Stumpf - Mousset
Romo

6 mm

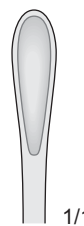

ER-80 1/1

8 mm



ER-81 1/1

10 mm



ER-82 1/1

12 mm



ER-83 1/1

14 mm



ER-84 1/1



Curette uterine

Uterine curettes

Uterusküretten

Utérines curettes

Curetas uterinas

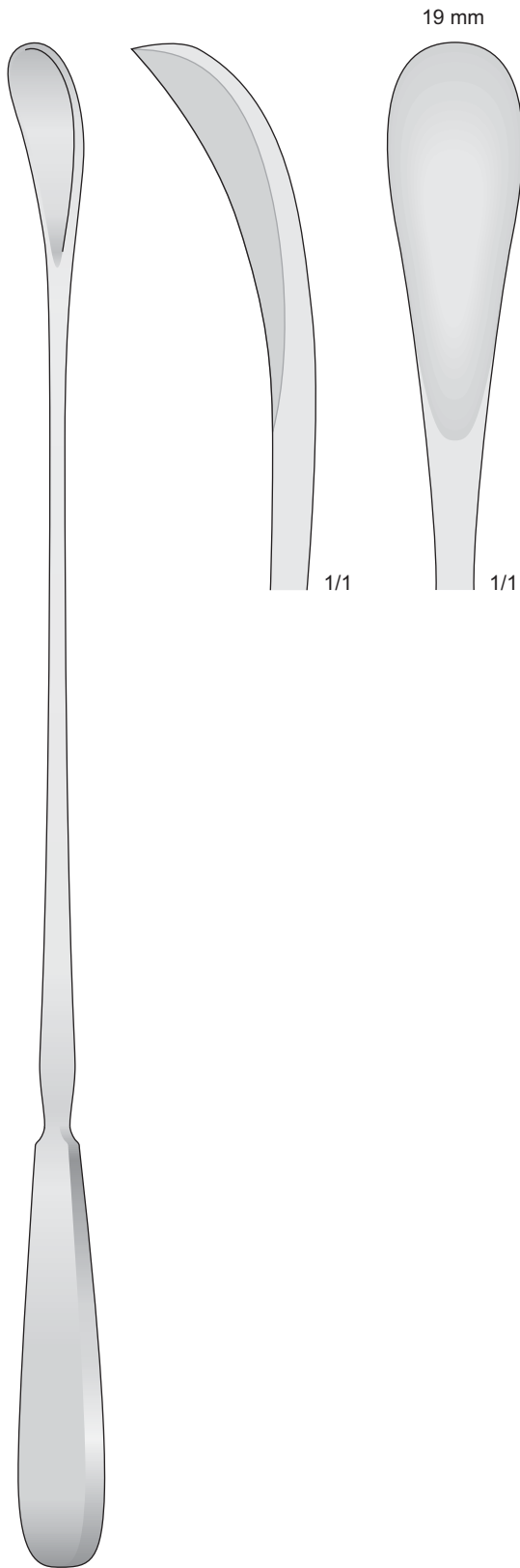

WALLICH
ER-90
420 mm

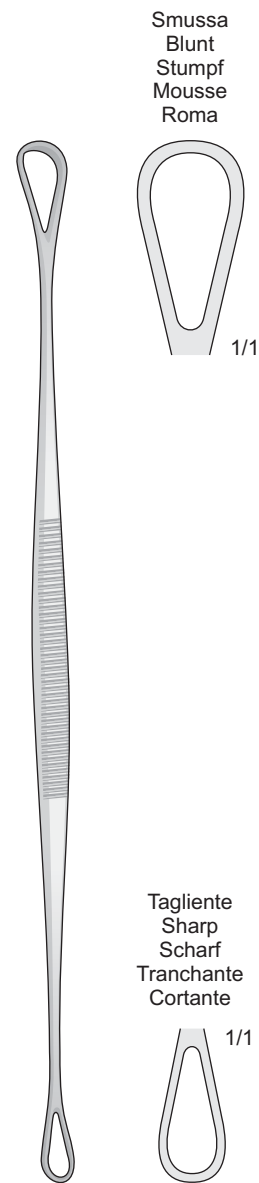

BLAKE
ER-88
275 mm

Tagliente
Sharp
Scharf
Tranchante
Cortante



Taglienti	Smussa
Scharp	Blunt
Scharf	Stumpf
Tranchantes	Mousse
Cortantes	Romas

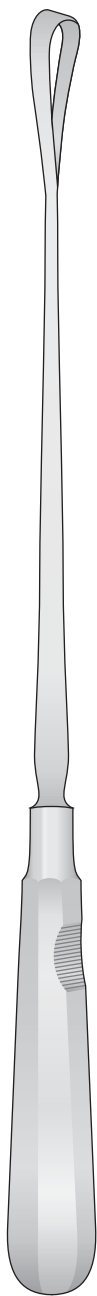
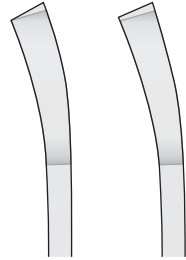

RECAMIER
ER-11/ER-28
310 mm

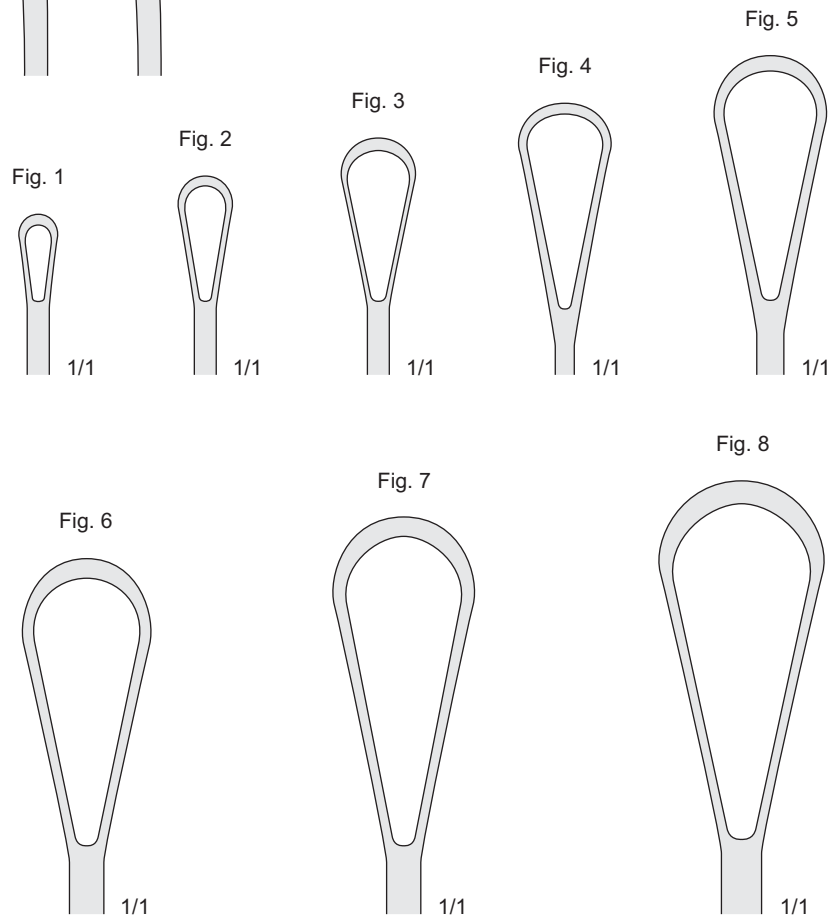

Fig.	Larghezza Width Breite	Taglienti-rigide Sharp-rigid Scharf-fest Tranchantes-rigides Cortantes-rigidas	Smusse-rigide Blunt-rigid Stumpf-fest Mousse-rigides Romas-rigidas
1	4 mm	ER-11	ER-21
2	6 mm	ER-12	ER-22
3	8 mm	ER-13	ER-23
4	10 mm	ER-14	ER-24
5	12 mm	ER-15	ER-25
6	14 mm	ER-16	ER-26
7	16 mm	ER-17	ER-27
8	18 mm	ER-18	ER-28



Curette uterine

Uterine curettes

Uterusküretten

Utérines cures

Curetas uterinas

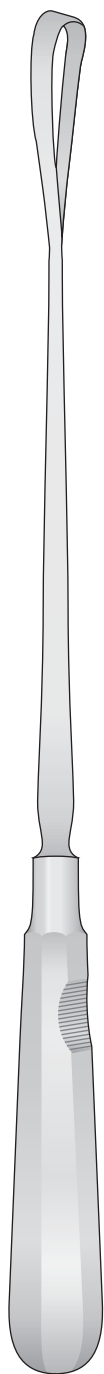

BUMM
ER-31/ER-42
310 mm

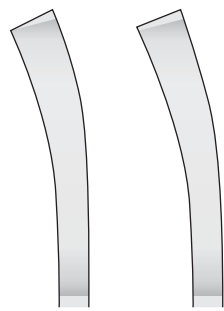

Tagliente	Smussa
Scharp	Blunt
Scharf	Stumpf
Tranchantes	Mousse
Cortantes	Romas

Malleabile
Malleable
Biegsam
Souples
Maleables

Fig. 3

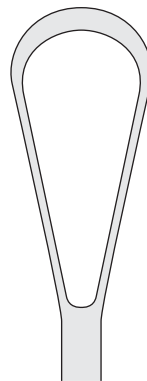
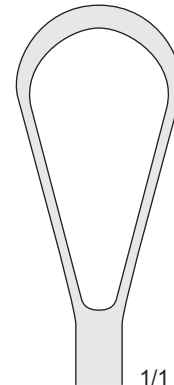

Fig. 4



1/1

Fig.	Larghezza Width Breite	Taglienti Sharp Scharf Tranchantes Cortantes	Smusse Blunt Stumpf Mousse Romas
3	18 mm	ER-31	ER-41
4	20 mm	ER-32	ER-42



Curette uterine

Uterine curettes

Uterusküretten

Utérines curettes

Curetas uterinas

Fig.	Larghezza Breite Width	Smusse malleabili - Blunt malleable Stumpf biegsam - Mousse malléables Romas maleables
0	16 mm	ER-140
1	18 mm	ER-141
2	19,5 mm	ER-142
3	21,5 mm	ER-143
4	23,5 mm	ER-144
5	26 mm	ER-145
6	28,5 mm	ER-146

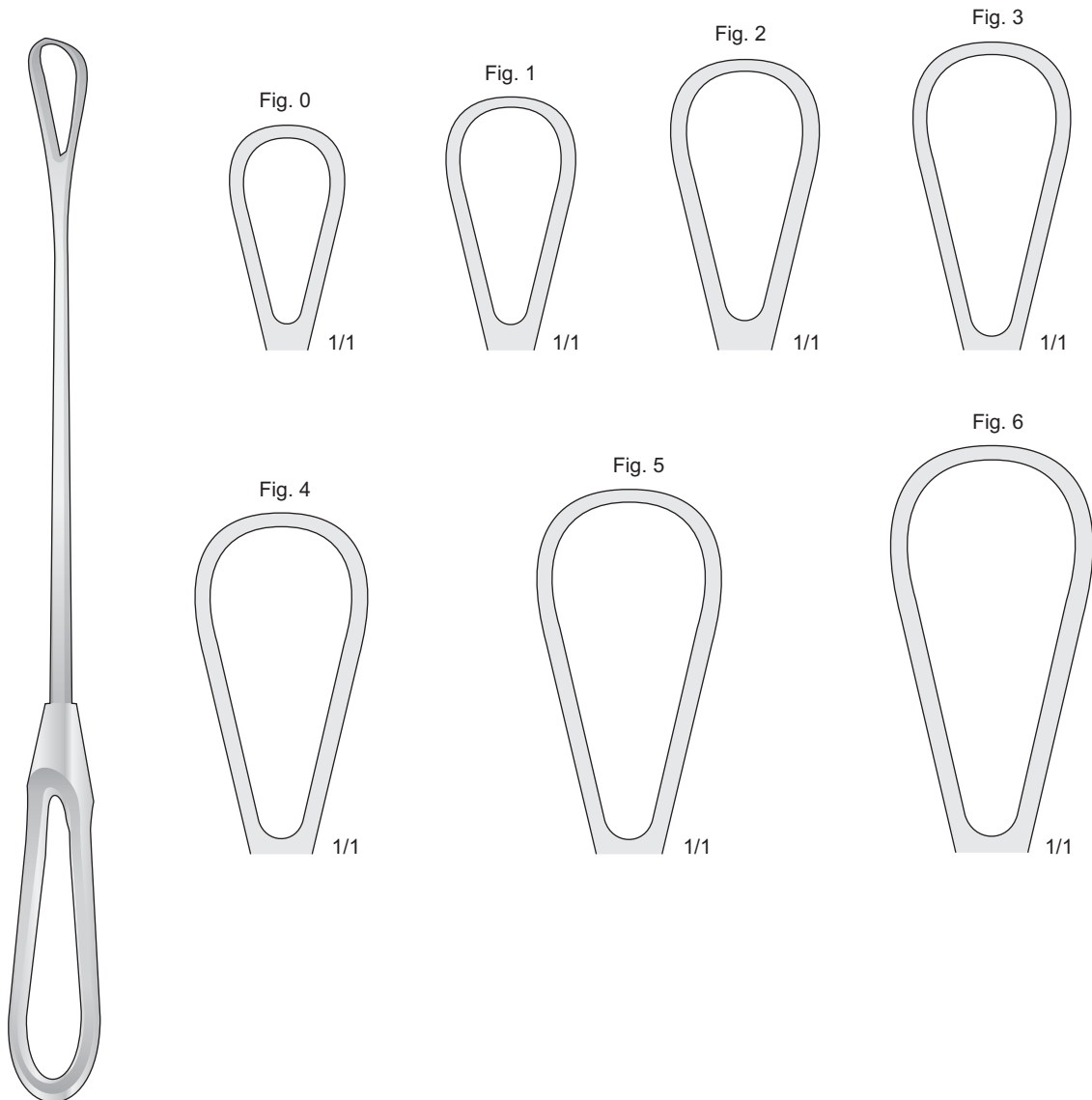

BUMM
ER-140/ER-146
290 mm



Speculum vaginali
e forcipe

Vaginal specule
and Midwifery forceps

Scheidenspekulum
und Geburtszange

Speculum
et forceps

Pinzas para el utero
y obstétricos

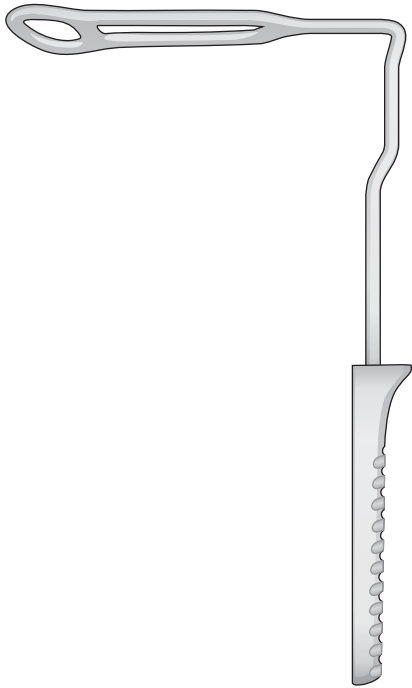

GENTOFT
ER-50
210 mm

Set 2 pezzi
Set 2 pieces
Set 2 Stück
Set 2 pièces
Set 2 piezas
ER-50 + ER-51

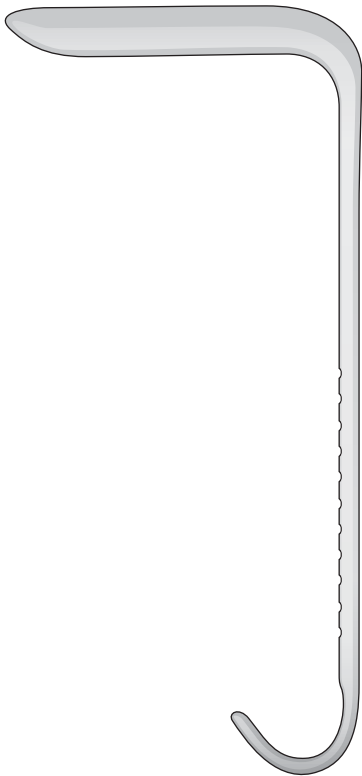

FENO
ER-51
230 mm

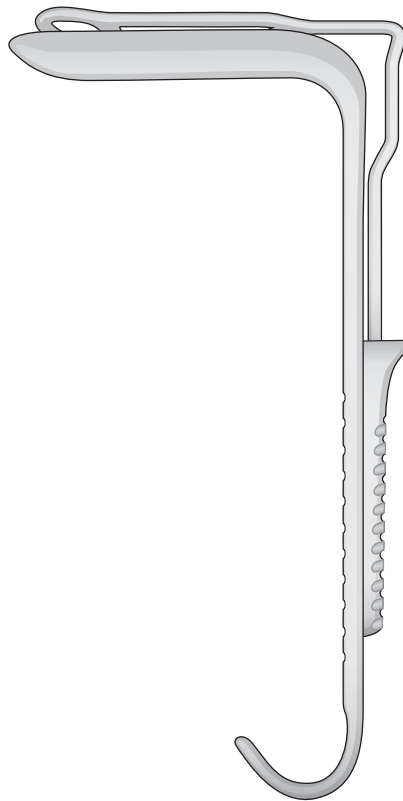

ER-53
230 mm

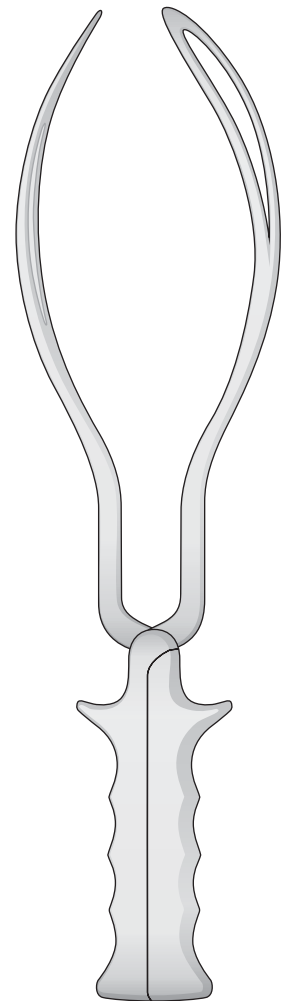

SIMPSON-BRAUN
ER-52
365 mm



Endospekula

Endocervical Specula

Endospecoli

Espéculos Endocervical

Endospéculum

Katheter-Einführungsinstrumente
Catheter introducing instruments
Strumenti per tendere ed introdurre i cateteri
Instrumentos para introducir catéteres
Mandrin pour introduire les sondes

Ø 1,2 mm

Endospekula für Harnröhre und
Cervix, ohne Sperre
Endospecula for cervix and urethra,
without ratchet

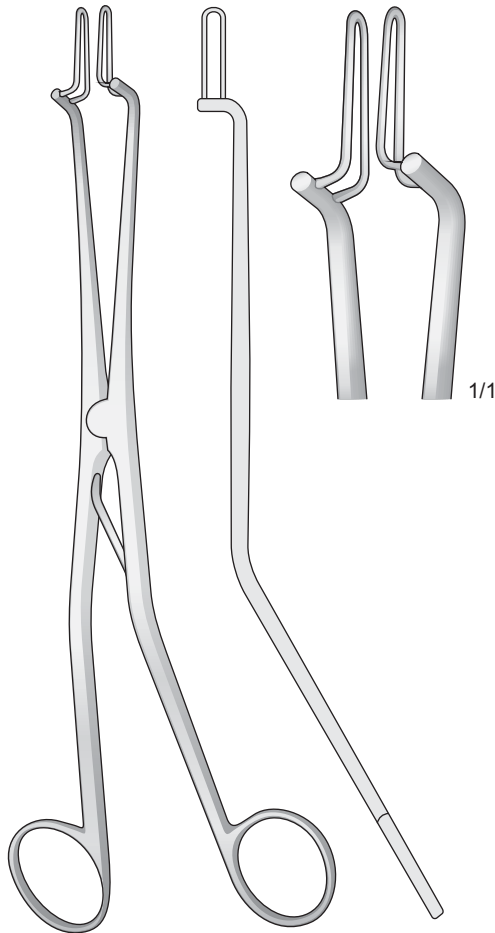

KOGAN
EB-110
240 mm

Endospekula für Harnröhre und
Cervix, mit Skalensperre und Fixierschraube
Endospecula for cervix and urethra,
with scale-ratchet and fixing screws
Con cremagliera a scala e vite di fissaggio
Con cremallera graduada y tornillo de fijación
Avec crémaillère à échelle et vis à fixation

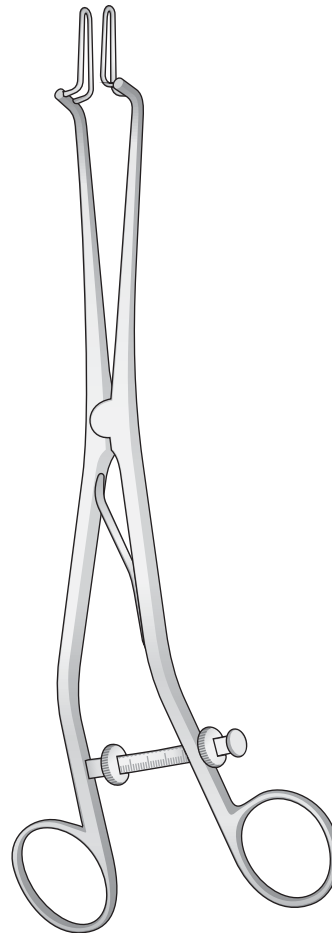

KOGAN
EB-111
240 mm

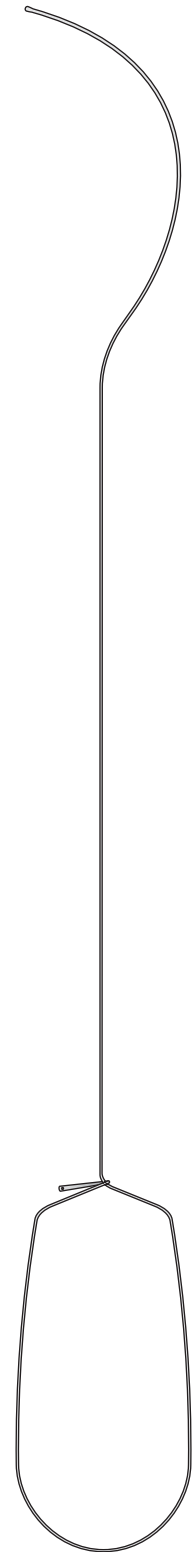

EA-94
425 mm

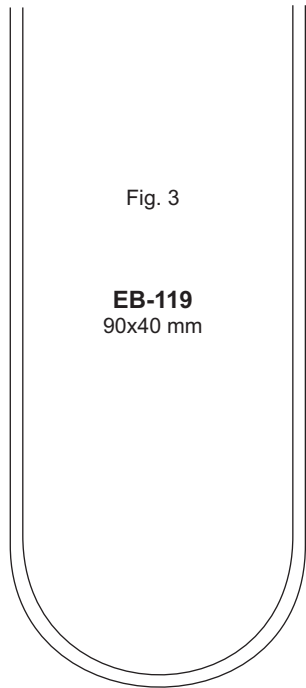

Fig. 3

EB-119
90x40 mm

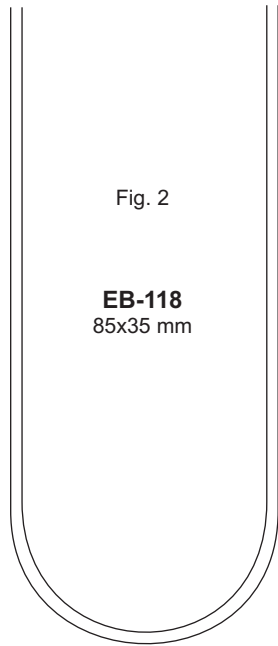

Fig. 2

EB-118
85x35 mm

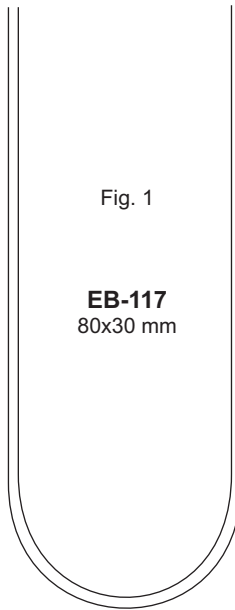
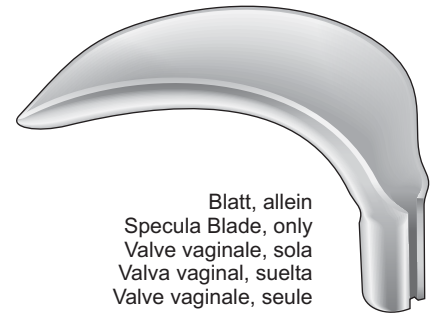

Fig. 1

EB-117
80x30 mm



Blatt, allein
Specula Blade, only
Valve vaginale, sola
Valva vaginal, suelta
Valve vaginale, seule

SCHERBAK
EB-117/EB-119

Blasenhalsperrer
Sounds Bladder
Dilatatore del collo vescicale
Sonda vesicales
Dilatateur pour le col vésical

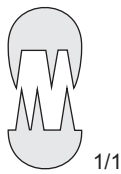
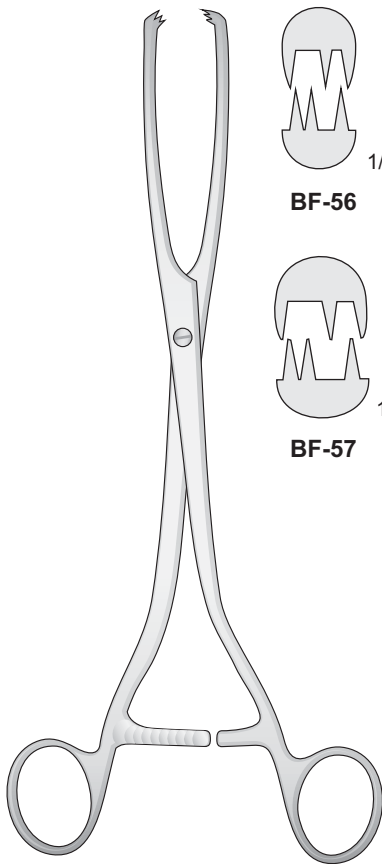

BF-56

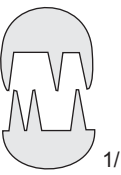

BF-57

MUSEUX
BF-56/BF-57
265 mm

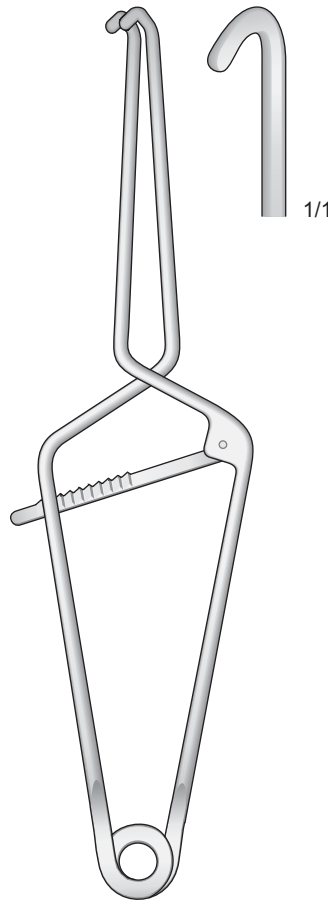

MILLIN
EB-17
280 mm

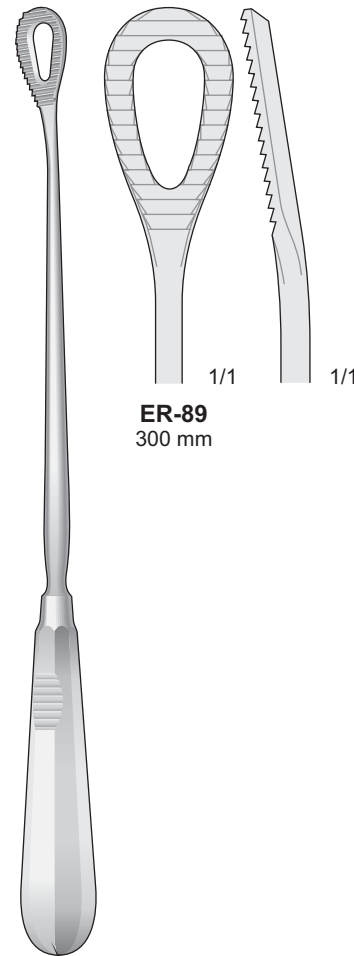

ER-89
300 mm

PESTALOZZA
ER-89
300 mm

Biopsiekürette
Uterine Biopsy Curette
Curette per biopsia
Curetts para biopsia
Curettes pour biopsie

6,0 mm

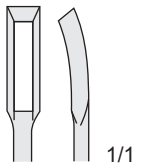

KEVORKIAN
ER-87
300 mm



Vaginalspekula

Vaginal Specula

Specoli vaginali

Espéculos vaginales

Spéculums vaginaux

Gewicht zum Vaginalspekulum
Weight for Vaginal Speculum
Peso per specolo vaginale
Peso para espéculo vaginal
Poids pour spéculum vaginal

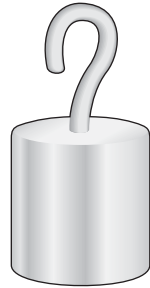

SCHERBAK
EB-294 10,5 mm 400 gr
EB-295 13 mm 800 gr

Blatt, allein
Specula Blade, only
Valve vaginale, sola
Valva vaginal, suelta
Valve vaginale, seule



SCHERBAK
EB-291/EB-292

Griff zum Vaginalspekulum
Handle for Vaginal Speculum
Manico per specolo vaginale
Mango para espéculo vaginal
Manche pour spéculum vaginal

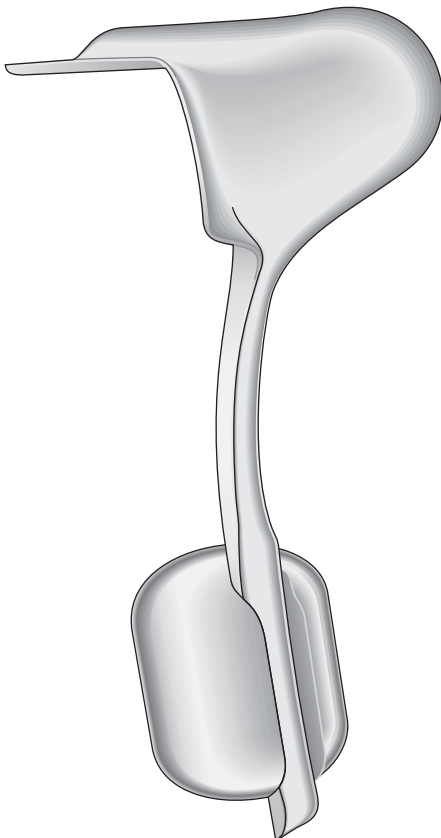

AUVARD
EB-290
230 mm



SCHERBAK
EB-293
200 mm

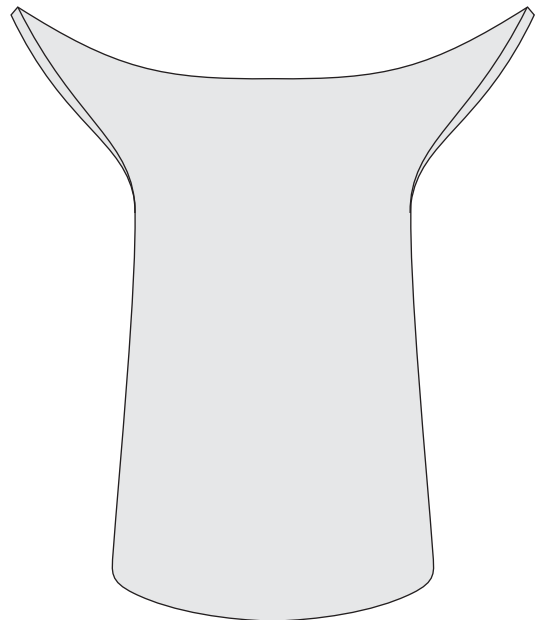

EB-292
81x45 - 70 mm

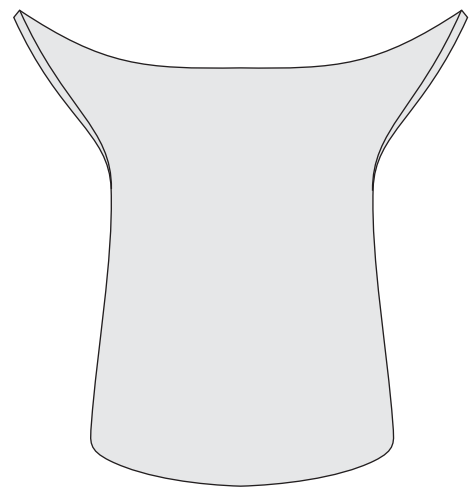

EB-291
62x40 - 60 mm



Scheidenspekula

Vaginal specula

Speculum vaginali

Espéculos vaginales

Spéculums vaginaux

Geschwärzt
Surface Black-finish
Superficie anti-riflesso
Surface noircie



ER-58
75 x 20 mm



ER-59
100 x 22 mm



ER-60
120 x 25 mm



Uterus-Dilatatoren

Uterine dilators

Dilatatori uterini

Dilatadores uterinos

Dilatateurs de col de l'utérus

EB-94

Komplettset mit 14 Uterusdilatoren ohne Metalltui
Set con 14 dilatatori uterini senza scatola



EB-95

Komplettset mit 26 Uterusdilatoren ohne Metalltui
Set con 26 dilatatori uterini senza scatola

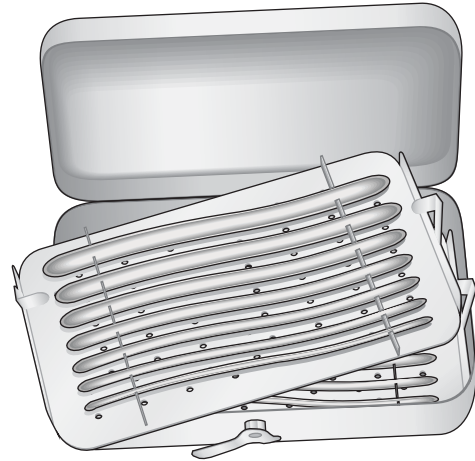

EB-96

Metalltui mit 14 Hegar Uterusdilatoren
Scatola con 14 dilatatori uterini Hegar



ER-134

Metalltui mit 13 Hegar Uterusdilatoren
Scatola con 13 dilatatori uterini Hegar

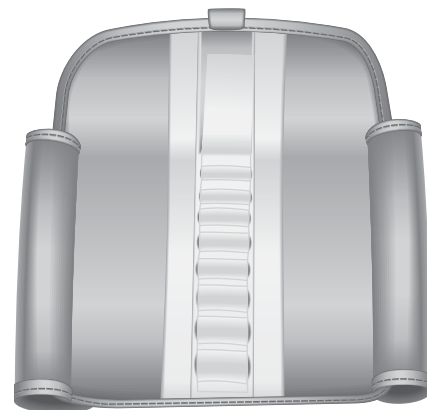

ER-133

mit 8 Uterusdilatoren
con 8 dilatatori uterini

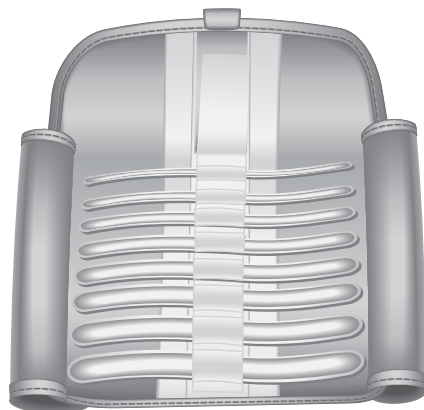

ER-135

für 8 Uterusdilatoren
per 8 dilatatori uterini

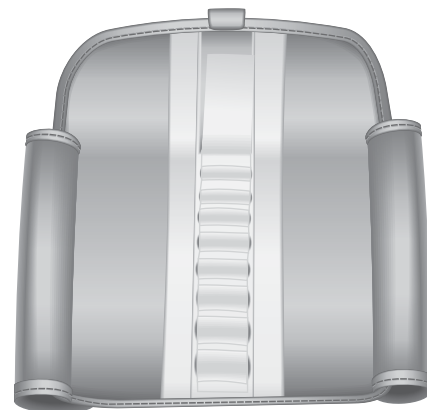

EB-97

Metalltui mit 26 Hegar Uterusdilatoren
Scatola con 26 dilatatori uterini Hegar

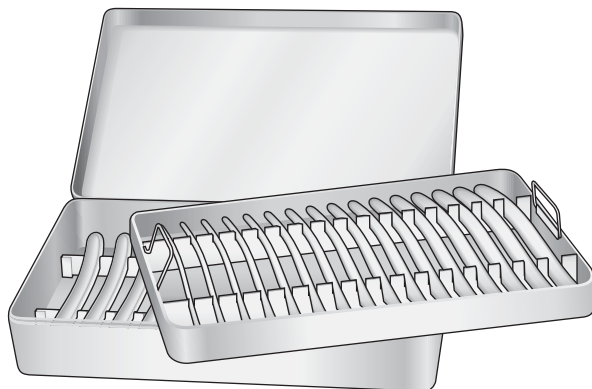

BS-17

Metalltui leer für 26 Hegar Uterusdilatoren
Scatola vuota per 26 dilatatori uterini Hegar

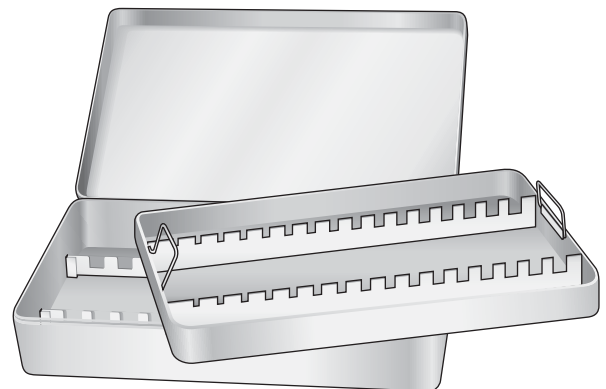



Uterusdepressor
Uterine Depressor
Depressore uterino
Depresor uterino
Dépresseur utérin



BRAUN
ER-76
275 mm

Sterilisierzangen zum Fassen und
Halten Steriler Instrumente
Sterilizing forceps for picking
up and holding of sterile instruments
Pinze per prelevare strumenti sterilizzati
Pinzas para esterilización
Pincas pour instruments stérilisés

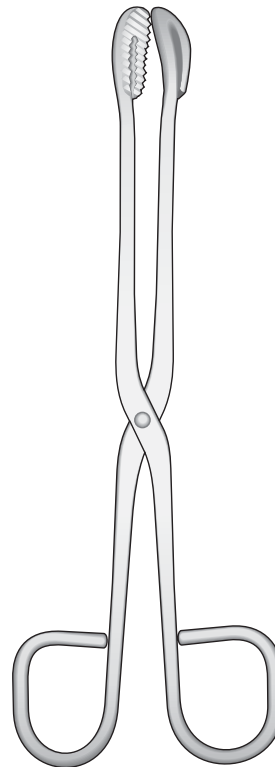

GS-13 200 mm
GS-14 300 mm

